



katalog náhradních dílů
automatického kotle

KP12S

PONAST spol. s r.o
Na Potůčkách 163
757 01 Valašské Meziříčí
ČESKÁ REPUBLIKA
tel.: 571 688111*
e-mail: ponast@ponast.cz

aktualizace: 05/12/2018





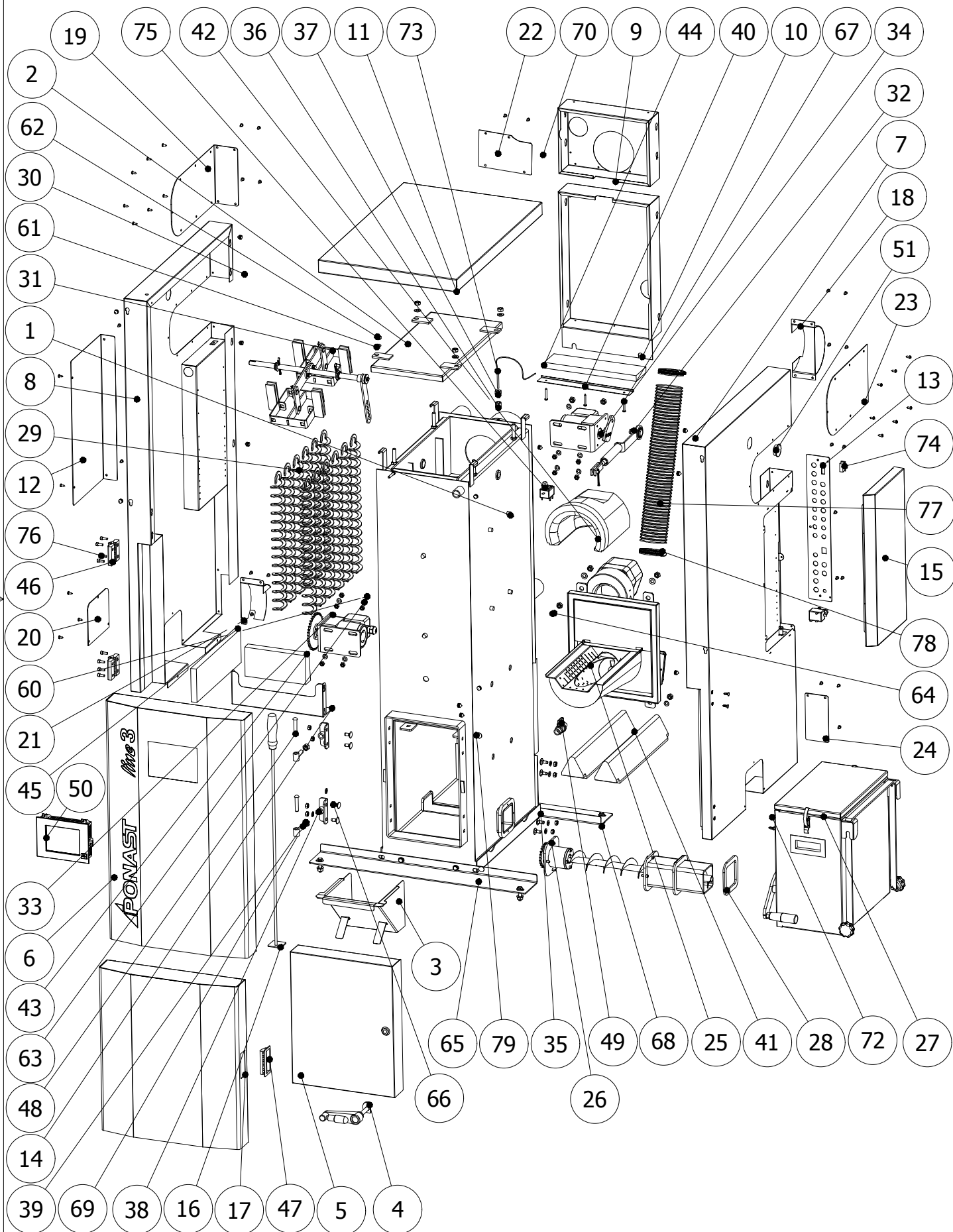



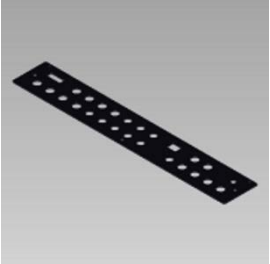

KOTEL KP12S

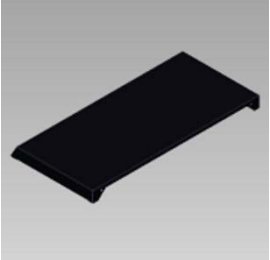



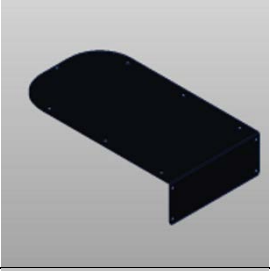
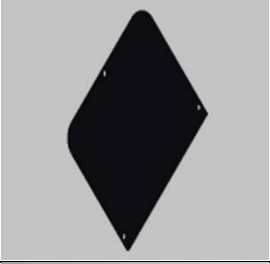

KOTEL KP12S	POZICE	POPIS	KÓD	ČÍSLO SOUČÁSTI	POČET KS	POZNÁMKY
	1	TĚLESO KOTLOVÉ KP12	PKXX1201	374.S01.000.A1	1	Sestava
	2	VÍKO	KKTX0002	002.S02.000.A2	1	Sestava
	3	LOPATKA KP12	PKTX0158	375.009.000.A3	1	
	4	KLIKA x2	KKTX0019	338.S04.000.A3	1	Sestava
	5	DVÍŘKA KP12	KKTX0020	374.S05.000.A2	1	Sestava
	6	ČELO KP12	PKMBB0134 PKMBB0391	726.S03.000.A3	1	NA PANTY NA ZÁMKY

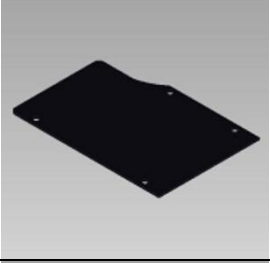
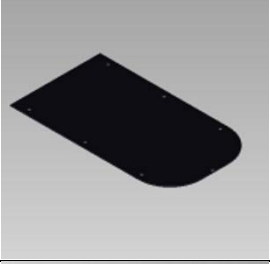
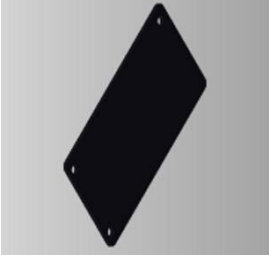
KOTEL KP12S	POZICE	POPIS	KÓD	ČÍSLO SOUČÁSTI	POČET KS	POZNÁMKY
	7	BOČNICE PRAVÁ	PKMD0132 PKMD0386	726.S02.000.A3	1	NA PANTY NA ZÁMKY
	8	BOČNICE LEVÁ	PKMD0126 PKMD0385	726.S01.000.A3	1	NA PANTY NA ZÁMKY
	9	KRYT ZADNÍ HORNÍ	PKMD0078	374.S10.001.A3	1	
	10	KRYT ZADNÍ SPODNÍ	PKMD0077	374.S10.002.A3	1	
	11	VÍKO HORNÍ- SVAŘENEC	PKMBB0140	726.S05.000.A4	1	
	12	KRYT KRABICE	PKMD0168	723.008.000.A3	1	

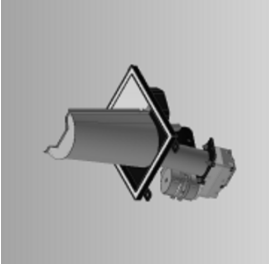
KOTEL KP12S	POZICE	POPIS	KÓD	ČÍSLO SOUČÁSTI	POČET KS	POZNÁMKY
	13	DESKA	PKMD0143	723.005.000.A4	1	
	14	VZPĚRA	PKMD0358	726.SA6.000.A4	1	
	15	KRYT JEDNOTKY BOČNÍ	PKMD0142	726.008.000.A3	1	
	16	ŠKRABKA	PKRX0001	001.S32.000.A4	1	
	17	KRYT DVEŘÍ KP12	PKMBB0138	726.S04.000.A3	1	
	18	KRYT ČISTĚNÍ	PKMD0081	397.S13.000.A3	1	

KOTEL KP12S	POZICE	POPIS	KÓD	ČÍSLO SOUČÁSTI	POČET KS	POZNÁMKY
	19	KRYTKA POHONU ČISTĚNÍ 2	PKMD0073	397.S07.008.A3	1	
	20	KRYTKA POHONU VYMETÁNÍ 1	PKMD0105	338.S06.005.A3	1	
	21	KRYT VYMETÁNÍ L+P	PKMD0062 PKMD0083	397.S14.000.A3	1	PRAVÝ LEVÝ
	22	ZAPLÁTOVÁNÍ	PKMD0079	374.015.000.A3	1	
	23	KRYTKA POHONU ČISTĚNÍ	PKMD0071	397.S07.006.A3	1	
	24	PLECH KRYCÍ	PKMD0074	397.S07.009.A4	1	

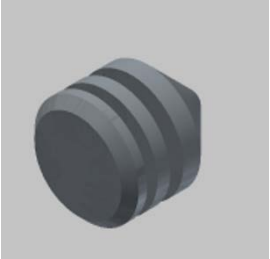
KOTEL KP12S	POZICE	POPIS	KÓD	ČÍSLO SOUČÁSTI	POČET KS	POZNÁMKY
	25	HOŘÁK KP50 EPO 2013 SIGM.	KHXX5032	522.V11.000.A3	1	Sestava
	26	VYMETÁNÍ POPELE KP12	KKTX0022	375.000.000.A3	1	Sestava
	27	POPELNICE 30L	KKTI0046 KKTI0047	664.000.000.A3	1	Sestava LEVÁ PRAVÁ
	28	TĚSNĚNÍ	PKTX0157	334.S08.005.A4	1	
	29	TURBULÁTOR PLOCHÝ 460mm	MRUZ0016	054.016.000.A4	12	
	30	KLÍČ	PKRX0008	286.000.000.A4	16	

KOTEL KP12S	POZICE	POPIS	KÓD	ČÍSLO SOUČÁSTI	POČET KS	POZNÁMKY
	31	ČISTĚNÍ VÝMĚNÍKU KP12	KKTX0062	795.000.000.A3	1	Sestava
	32	MECHANISMUS ČISTĚNÍ	KKTX0024	424.000.000.A3	1	Sestava
	33	POHON VYMETÁNÍ	KKTX0026	336.000.000.A3	1	Sestava
	34	POHON ČISTĚNÍ TAHŮ	KKTX0025	374.S18.000.A3	1	Sestava
	35	DRŽÁK KOTLE	PKRX0006	005.017.000.A3	2	
	36	REDUKCE DÍL 1	PKRX0062	792.001.000.A4	1	



KOTEL KP12S	POZICE	POPIS	KÓD	ČÍSLO SOUČÁSTI	POČET KS	POZNÁMKY
	37	REDUKCE DÍL 2	PKRX0063	792.002.000.A4	1	
	38	PANT DÍL 2	PKTX0134	397.S01.S43.A3	2	
	39	PANT DVÍŘEK	PKTX0121	054.S05.S03.A4	2	
	40	DRŽÁK SIBRALU	PKMD0088	374.055.000.A4	1	
	41	KERAMIKA TROJÚHELNÍKOVÁ	MTKE0135	420.900.000.A3	2	
	42	REFLEKTOR KERAMICKÝ	MTKE0020	001.042.000.A3	1	

KOTEL KP12S	POZICE	POPIS	KÓD	ČÍSLO SOUČÁSTI	POČET KS	POZNÁMKY
	43	KERAMIKA NAD DVÍŘKA KP11	MTKE0005	056.021.000.A4	1	
	44	SIBREX 300 20x80x319	MTIZ0020		1	
	45	SIBREX 20x115x365	MTIZ0009		1	
	46	Pant ELESA CFA.65-SL-H-V	PKTX0295		2	
	47	Rukojeť EPR_90_PF_C1	MRUZ0205		1	
	48	NÝT 10x50 Fe	MSRX0032	DIN 660	2	

KOTEL KP12S	POZICE	POPIS	KÓD	ČÍSLO SOUČÁSTI	POČET KS	POZNÁMKY
	49	VENTIL VYPOŠTĚCÍ S PÁČKOU	MRUZ0024		1	
	50	TERMINÁL DOTYKOVÝ HZS 555-S	METR0073		1	
	51	ZÁSLEPKA ČERNÁ 35-38mm	MRUZ0228		2	
	60	Šestihranné matice - M8	MSMX0016	ISO 4032	24	
	61	Ploché podložky - 10	MSPX0005	ISO 7089	16	
	62	Šestihranné matice - M10	MSMX0041	ISO 4032	14	

KOTEL KP12S	POZICE	POPIS	KÓD	ČÍSLO SOUČÁSTI	POČET KS	POZNÁMKY
	63	Ploché podložky - 8	MSPX0001	ISO 7089	28	
	64	Vějířová pojistná podložka - A 10,5	MSPX0003	DIN 6797	2	
	65	Šestihranný šroub - M8 x 20	MSSX0002	ISO 4017	4	
	66	Šroub s půlk. hl.a 4hr.kr. - M8 x 20	MSSX0207	DIN 603	8	
	67	Šroub do plechu - ST4,8 x 38	MSSX0042	ISO 7049	3	
	68	Šestihranný šroub - M8 x 40	MSSX0027	DIN 933	4	

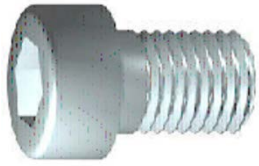
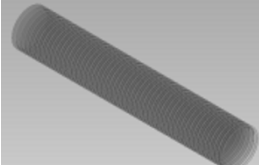
KOTEL KP12S	POZICE	POPIS	KÓD	ČÍSLO SOUČÁSTI	POČET KS	POZNÁMKY
	69	Šestihranné matice - M12	MSMX0007	ISO 4032	2	
	70	Šrouby samořezné - ST 4,8 x 13	MSSX0118	ISO 7049	44	ČERNÝ CHROMÁT
	72	Nýt zarážecí pr.5mm 27024050	MSSX0125		4	
	73	Snímač teploty TR 050J-x TCK, 1,4m	METRO108		1	
	74	Vypínač SSk 315 RED	MERX0579		1	
	75	HAVARIJNÍ TERMOSTAT LY 26 I	METRO049		2	

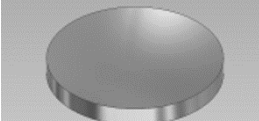
KOTEL KP12S	POZICE	POPIS	KÓD	ČÍSLO SOUČÁSTI	POČET KS	POZNÁMKY
	76	Šroub s válcovou hlavou - M6 x 16	MSSX0224	DIN 912	8	
	77	HADICE FLEXADUR PU-1NO DN 80x1000	MRUZ0018		1	
	78	SPONA HADICOVÁ 70-90 NEREZ	MRUZ0089		2	
	79	MAGNET 18x2	MRUZ0077		2	

TĚLESO KOTLOVÉ

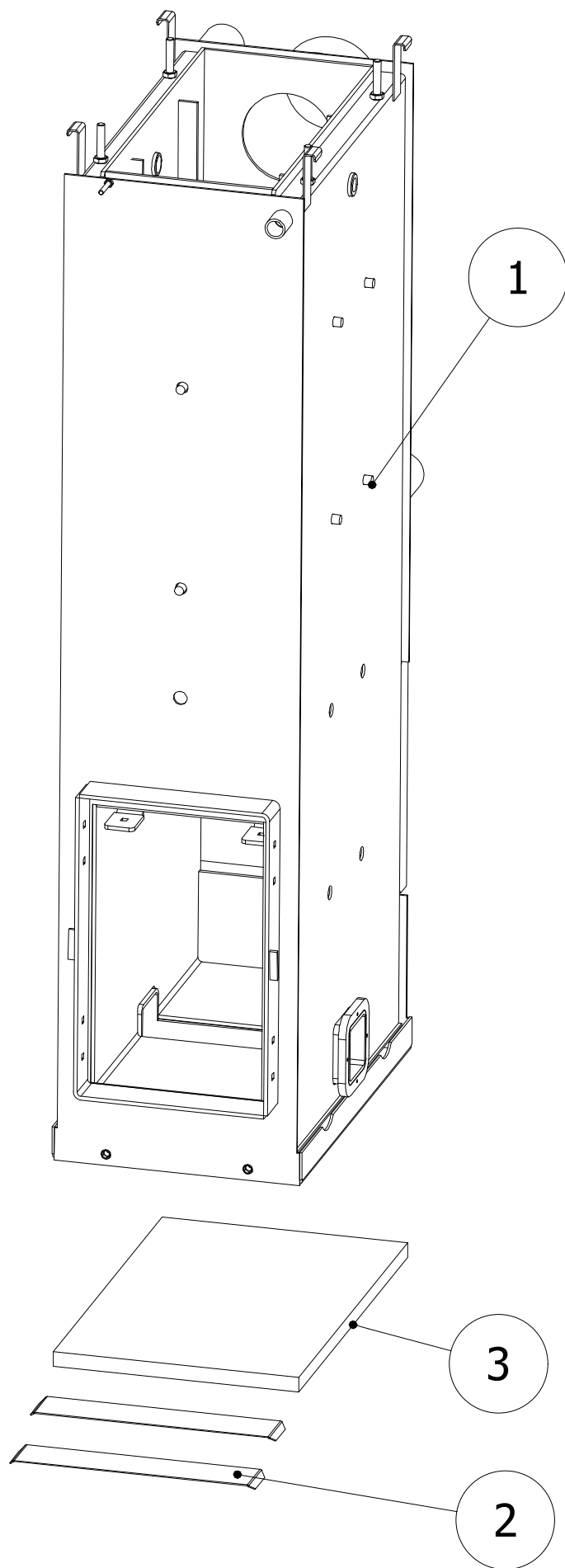

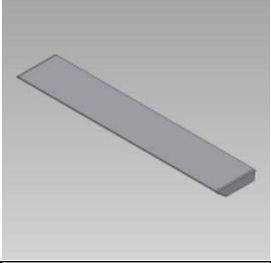
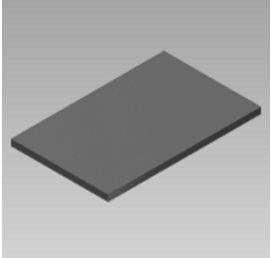
TĚLESO KOTLOVÉ KP12	POZICE	POPIS	KÓD	ČÍSLO SOUČÁSTI	POČET KS	POZNÁMKY
	1	TĚLESO KOTLOVÉ KP12	PKXX1201	374.S01.000.A1	1	
	2	DRŽÁK IZOLACE KP11,KP12	PKTX0346	PKTX0346	2	
	3	IZOLACE 20x515x327	PKTX0342		1	

VÍKO

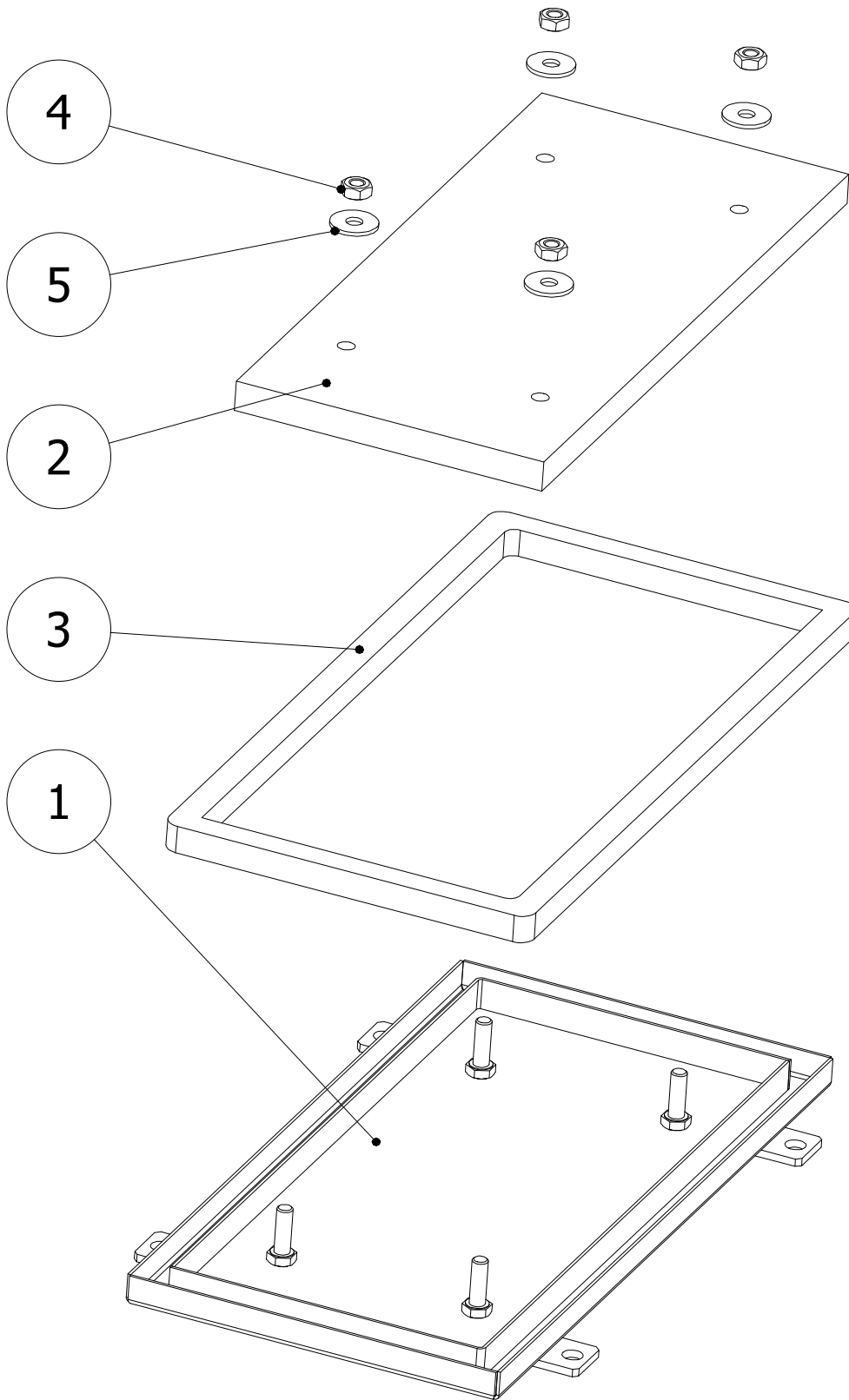

VÍKO	POZICE	POPIS	KÓD	ČÍSLO SOUČÁSTI	POČET KS	POZNÁMKY
	1	VÍKO KOTL.TĚLES A KP10,11	PKTX0026	002.002.000.A2	1	
	2	SIBREX 140 20x208x446	MTIZ0006		1	
	3	ŠŇŮRA TĚSNÍCÍ 18x18	MRUZ0133		1.4m	
	4	Šestihránná matice - M10	MSMX000 2	DIN 934	4	Zn
	5	Podložka - 10,5	MSPX0004	DIN 9021	4	Zn

KLIKA

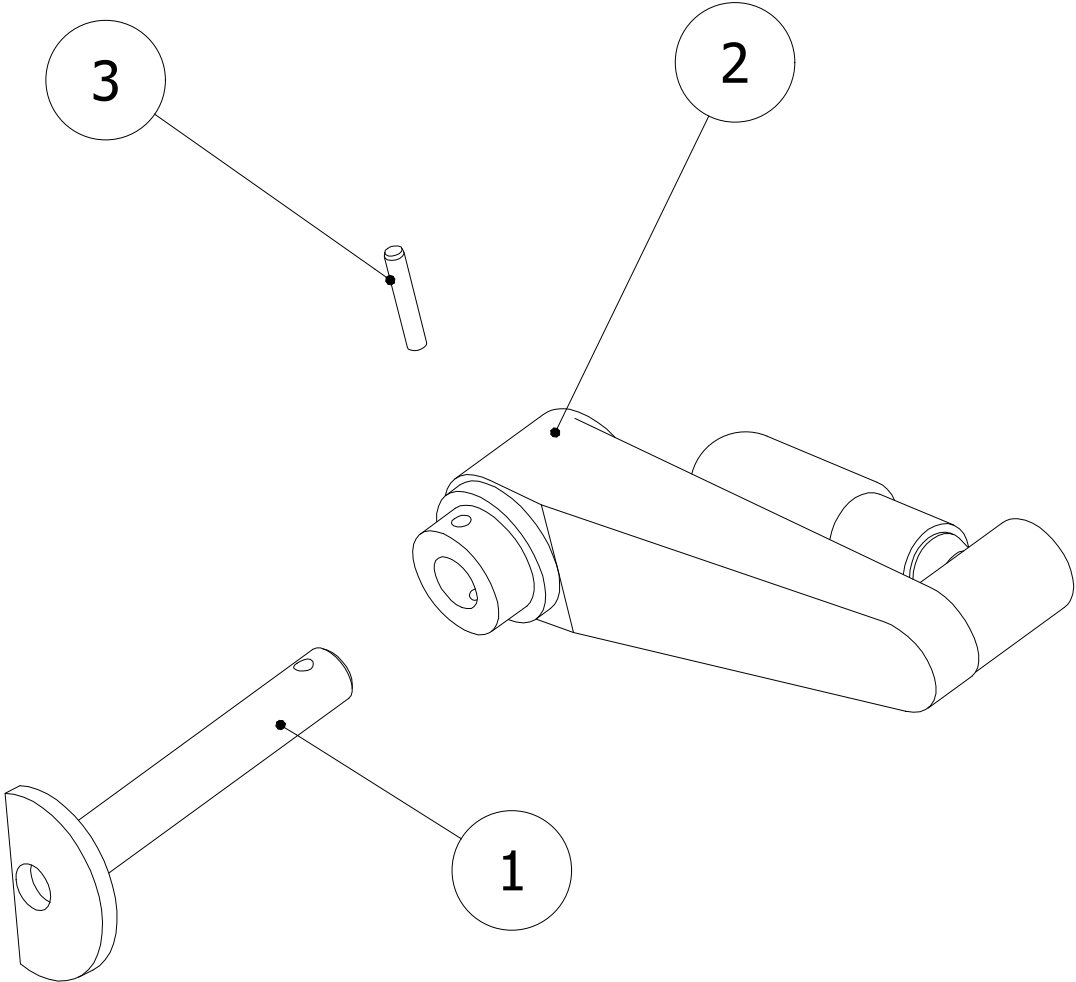

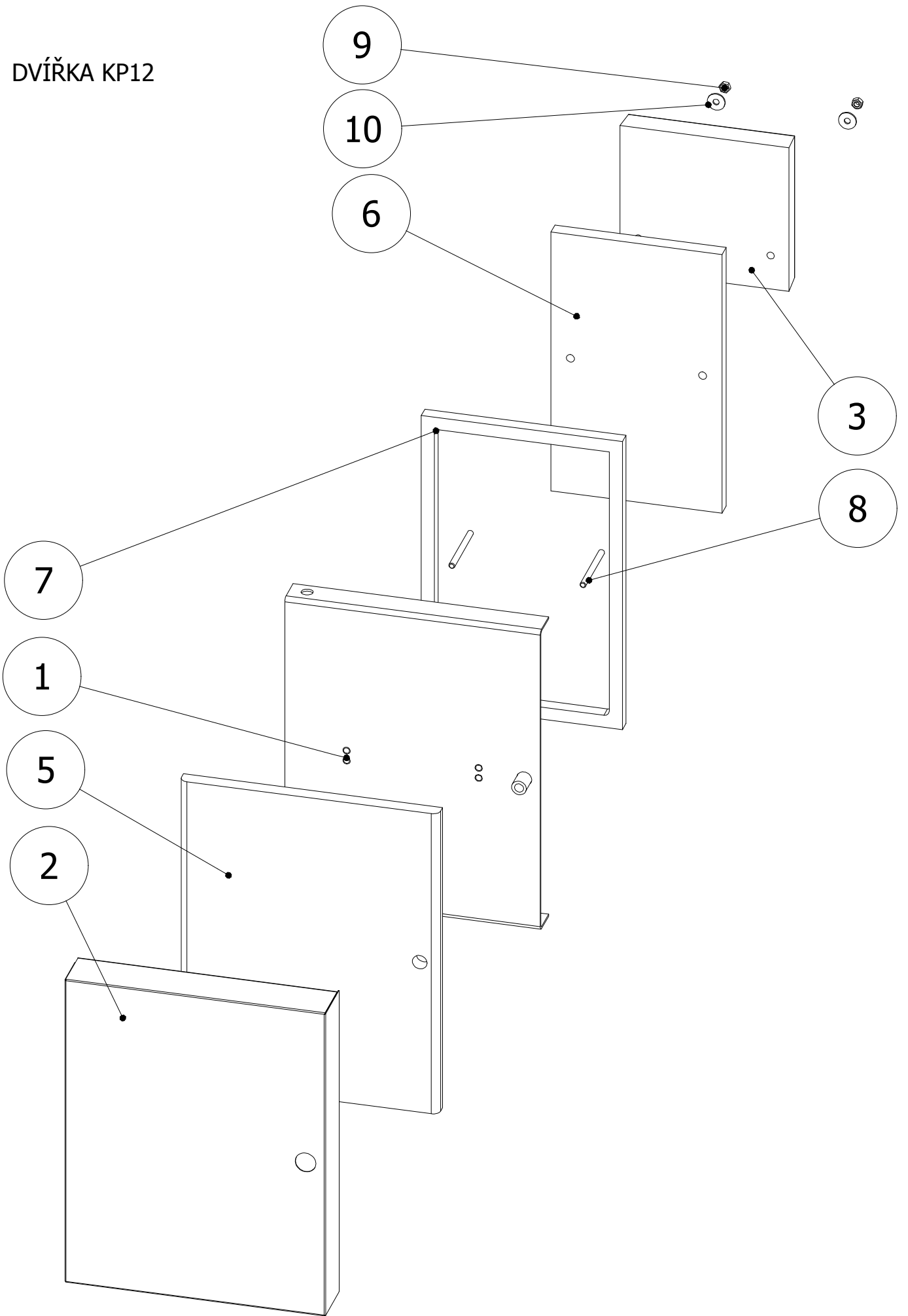

KLIIKA	POZICE	POPIS	KÓD	ČÍSLO SOUČÁSTI	POČET KS	POZNÁMKY
	1	DŘÍK KLIKY	PKTX0118	054.S04.001.A3	1	
	2	KLIIKA SKLAPOVACÍ ELESA GANTER	MRUZ0117	MT.100-AT+IR	1	KÓD 44317
	3	Kolík - 4 x 24 - A (kalený)	MSRX0003	ISO 8734	1	

DVÍŘKA KP12

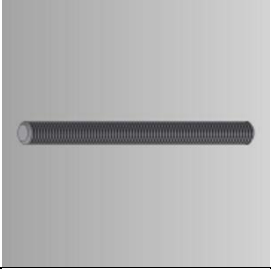

DVÍŘKA KP12	POZICE	POPIS	KÓD	ČÍSLO SOUČÁSTI	POČET KS	POZNÁMKY
	1	DVÍŘKA KP12	PKTX0137	374.005.000.A3	1	
	2	KRYT DVÍŘEK	PKMD0080	374.012.000.A3	1	
	3	KERAMIKA NA DVÍŘKA KP11	MTKE0007	056.005.008.A4	1	
	5	IZOLACE DVÍŘEK KP12 20x353x449	MTIZ0011		1	
	6	SIBREX 300 20x387x233	MTIZ0017		1	
	7	ŠŇŮRA TĚSNÍCÍ 18x18x1350	MRUZ0133		1	

DVÍŘKA KP12	POZICE	POPIS	KÓD	ČÍSLO SOUČÁSTI	POČET KS	POZNÁMKY
	8	TYČ ZÁVITOVÁ M8x95	PKTX0117		2	
	9	Šestihhrané matice - M8	MSMX0016	ISO 4032	2	
	10	Podložka - 8,4	MSPX0008	DIN 9021	2	

HOŘÁK KP50 EPO 2013 SIGMATEK

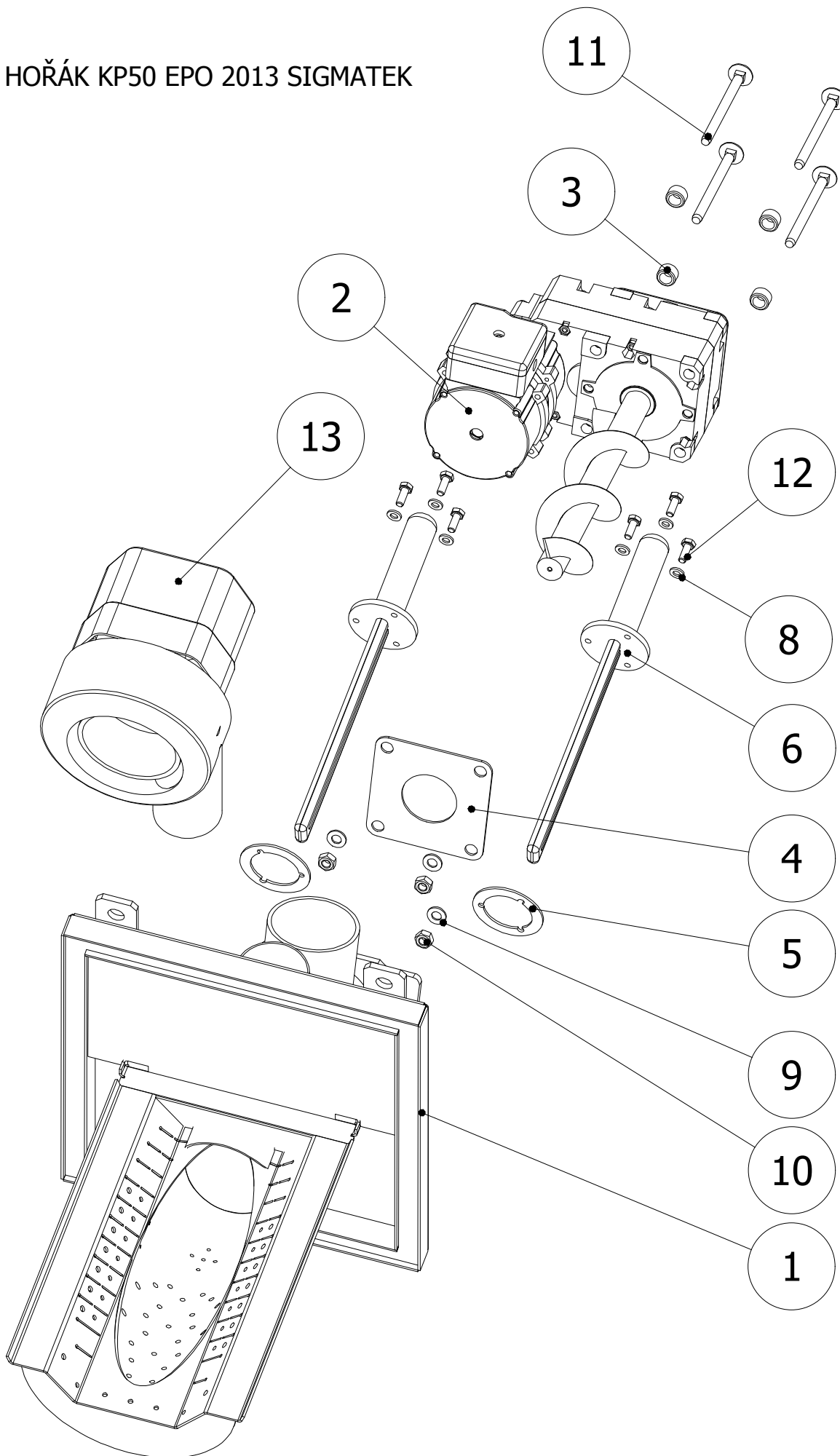

HOŘÁK KP50 EPO 2013 SIGM.	POZICE	POPIS	KÓD	ČÍSLO SOUČÁSTI	POČET KS	POZNÁMKY
	1	HOŘÁK KP50 SVAŘ.TĚS.SIBR	KHXX5002	522.S00.000.A3	1	Sestava
	2	PODAVAČ P2 EPO 2013	KHXX5033	522.S07.000.A3	1	Sestava
	3	DISTANCE DRŽÁKU SNÍMAČE	PHXX0162	428.400.000.A4	4	
	4	MEZIKUS PRO EPOMOTORY 2013	PHXX0161	428.300.000.A4	1	
	5	TĚSNĚNÍ	PHXX0115	493.021.000.A4	2	
	6	Spirála zpalovací 500W	MERX0011	spirála 500W	2	

HOŘÁK KP50 EPO 2013 SIGM.	POZICE	POPIS	KÓD	ČÍSLO SOUČÁSTI	POČET KS	POZNÁMKY
	8	Ploché podložky - 6	MSPX0026	ISO 7089	6	
	9	Ploché podložky - 8	MSPX0001	ISO 7089	4	
	10	Šestihránné matice - M8	MSSX001 6	ISO 4032	4	
	11	Šroub s půlk.hl.a 4rh.krčkem - M8 x 100	MSSX0129	DIN 603	4	
	12	Šestihránný šroub - M6 x 16	MSSX0015	ISO 4017	6	Zn
	13	VENTILÁTOR RLG 97	MEVE0005		1	



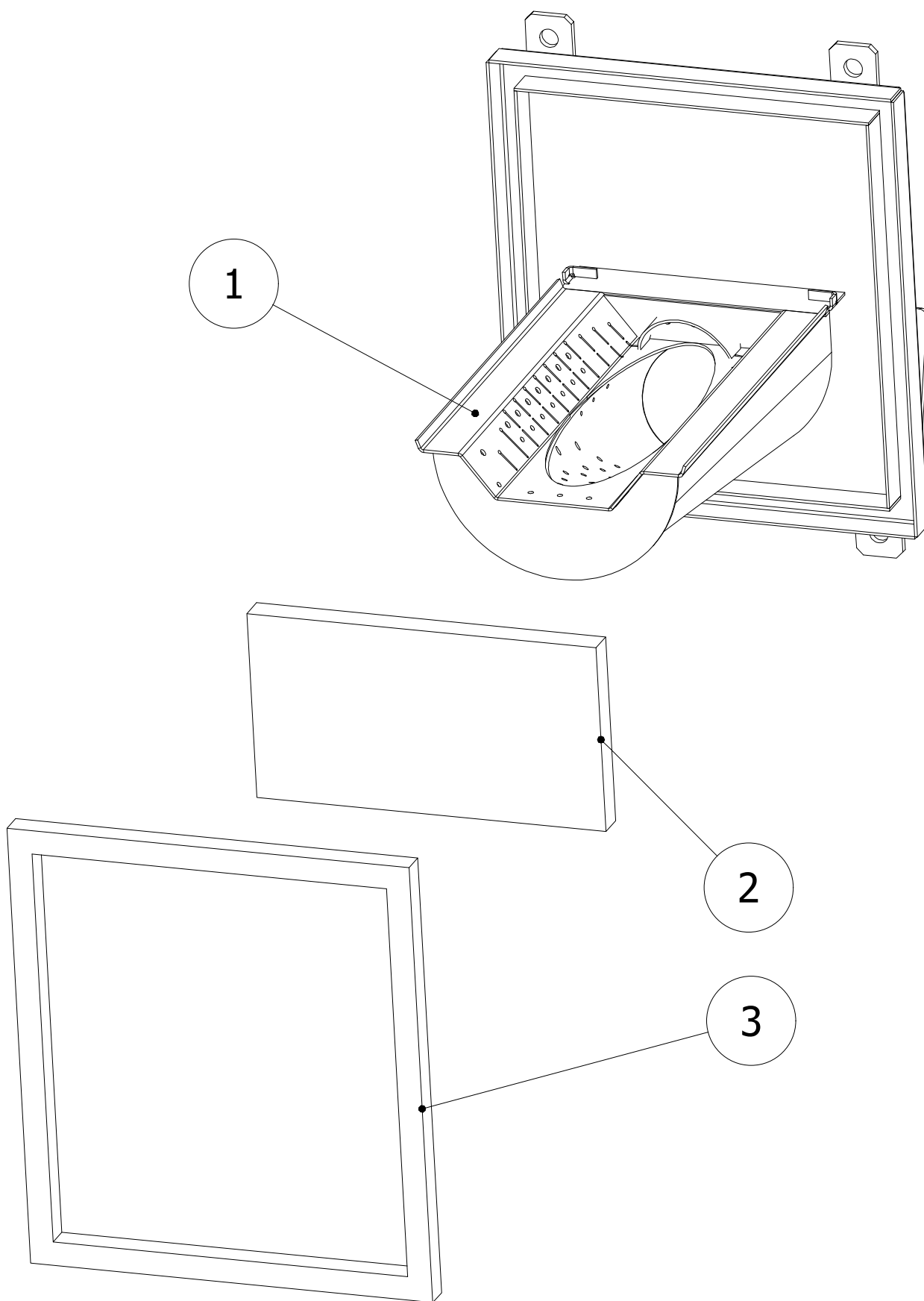

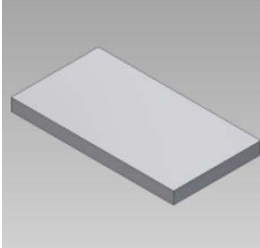
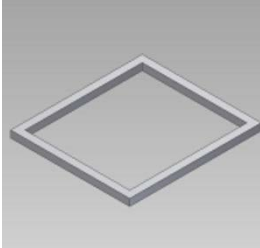
Hořák KP50 svař.těs.sibr.



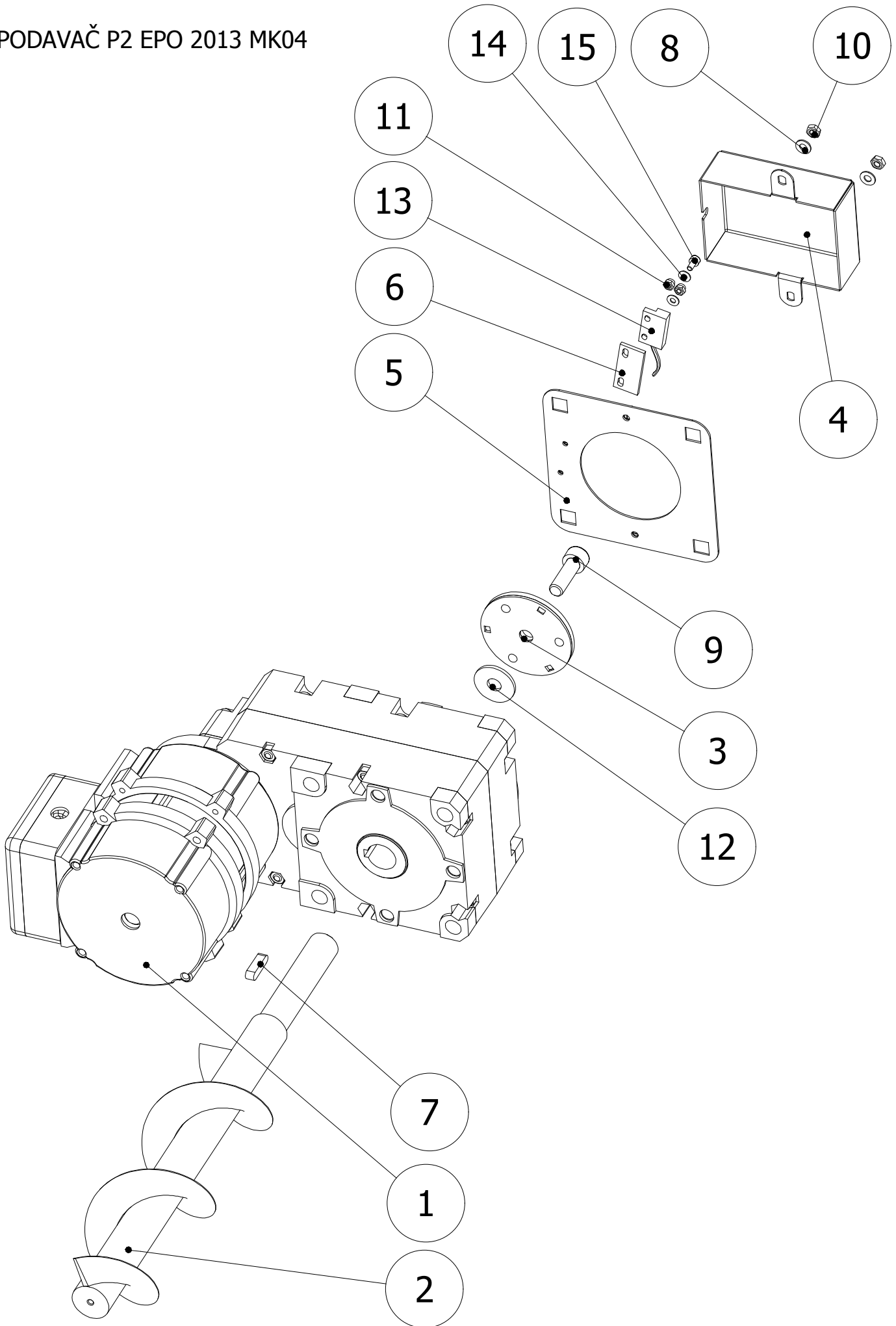

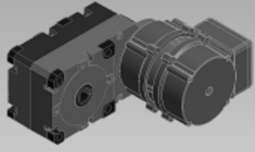

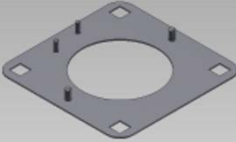
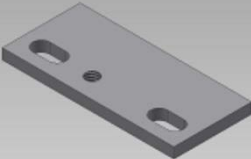

HOŘÁK KP50 SVAŘ.TĚS.SIBR.	POZICE	POPIS	KÓD	ČÍSLO SOUČÁSTI	POČET KS	POZNÁMKY
	1	Hořák KP 50 svařenec	PHXX5001	522.S00.001.A3	1	
	2	DESKA 20x264x143	MTIZ0003		1	
	3	ŠŇŮRA TĚSNÍCÍ 18x18	MRUZ0133		1.26m	

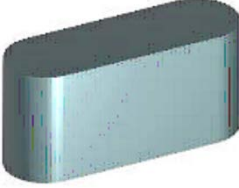
PODAVAČ P2 EPO 2013 MK04

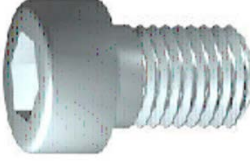

PODAVAČ P2 EPO 2013 MK04	POZICE	POPIS	KÓD	ČÍSLO SOUČÁSTI	POČET KS	POZNÁMKY
	1	Motor EPO MRB 0,09kW/4p 1:85 1x230V/50H z	MEMP003 5		1	
	2	ŠNEK KP 50 ABM	PHXX0034	432.000.000.A3	1	Délka 328mm
	3	KOLO SNÍMAČE MEDER MK04/EPO	PHXX0213	PHXX0213	1	
	4	KRABIČKA SNÍMAČE SIGMATEK	MHVH011 5	786.000.000.A4	1	
	5	DRŽÁK SNÍMAČE OTÁČEK	MHVH011 9	428.100.000.A4	1	
	6	Adaptér pro MK04	PHXX0214	798.110.001.A4	1	

PODAVAČ P2 EPO 2013 MK04	POZICE	POPIS	KÓD	ČÍSLO SOUČÁSTI	POČET KS	POZNÁMKY
	7	Těsné pero 5e7 x 5 x 20	MSRX0005	DIN 6885	1	
	8	Ploché podložky - 4	MSPX0014	ISO 7089	2	
	9	Šroub s válcovou hlavou - M8 x 25	MSSX0095	DIN 912	1	
	10	Šestihranné matice - M4	MSSX0012	ISO 4032	2	
	11	Šestihranná matice pojistná - M3	MSMX002 4	DIN 985	2	
	12	Podložka - 8,4	MSPX0008	DIN 9021	1	

PODAVAČ P2 EPO 2013 MK04	POZICE	POPIS	KÓD	ČÍSLO SOUČÁSTI	POČET KS	POZNÁMKY
	13	Snímač MEDER MK04-1A66- dl. 1900mm	MERX0777		1	
	14	Ploché podložky - 3	MSPX0031	ISO 7089	2	
	15	Šroub s válcovou hlavou - M3 x 6	MSSX0226	DIN 912	1	

VYMETÁNÍ POPELE

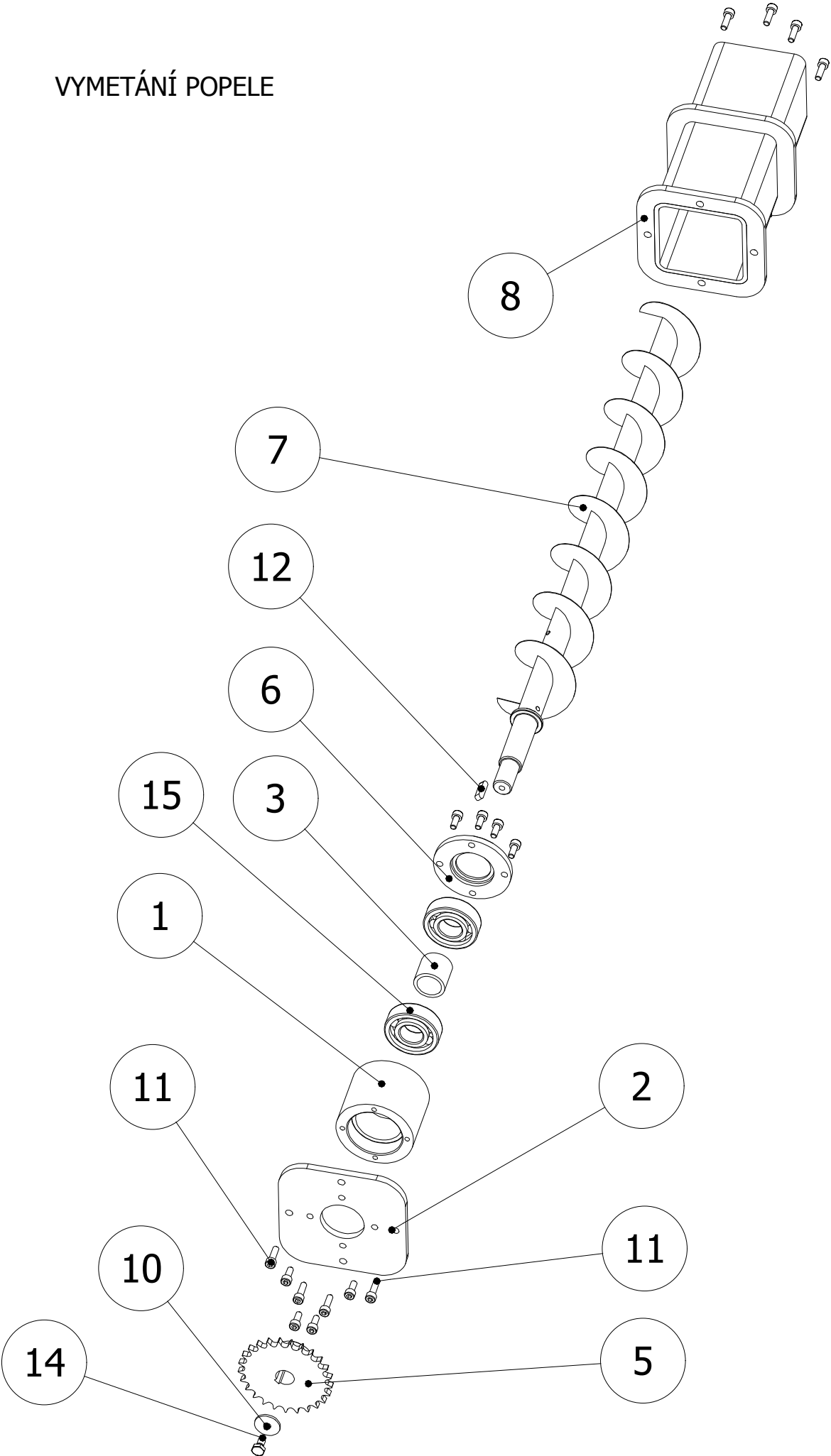



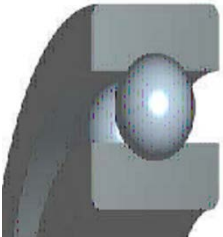

VYMETÁNÍ POPELE KP12	POZICE	POPIS	KÓD	ČÍSLO SOUČÁSTI	POČET KS	POZNÁMKY
	1	NÁBOJ	PKTX0140	334.001.000.A4	1	
	2	VÍKO 1	PKTX0150	334.002.000.A4	1	
	3	DISTANCE	PKTX0440	334.003.000.A4	1	
	5	KOLO ŘETĚZOVÉ S NÁB.3/8"x7/32 "	PKTX0143	334.005.000.A4	1	
	6	VÍKO 2	PKTX0144	334.006.000.A4	1	
	7	ŠNEK	PKTX0151	375.S07.000.A3	1	

VYMETÁNÍ POPELE KP12	POZICE	POPIS	KÓD	ČÍSLO SOUČÁSTI	POČET KS	POZNÁMKY
	8	VEDENÍ ŠNEKU	PKTX0153	334.S08.000.A3	1	
	10	Podložka 6	MSPX001 1	DIN 440R	1	
	11	Šroub s válcovou hlavou - M5 x 16	MSSX0055	DIN 912	8	
	12	Těsné pero 5e7 x 5 x 20	MSRX000 5	DIN 6885	1	
	13	Šroub s válcovou hlavou - M5 x 12	MSSX0137	DIN 912	8	
	14	Šestihranný šroub - M6 x 10	MSSX0019	DIN 933	1	Zn

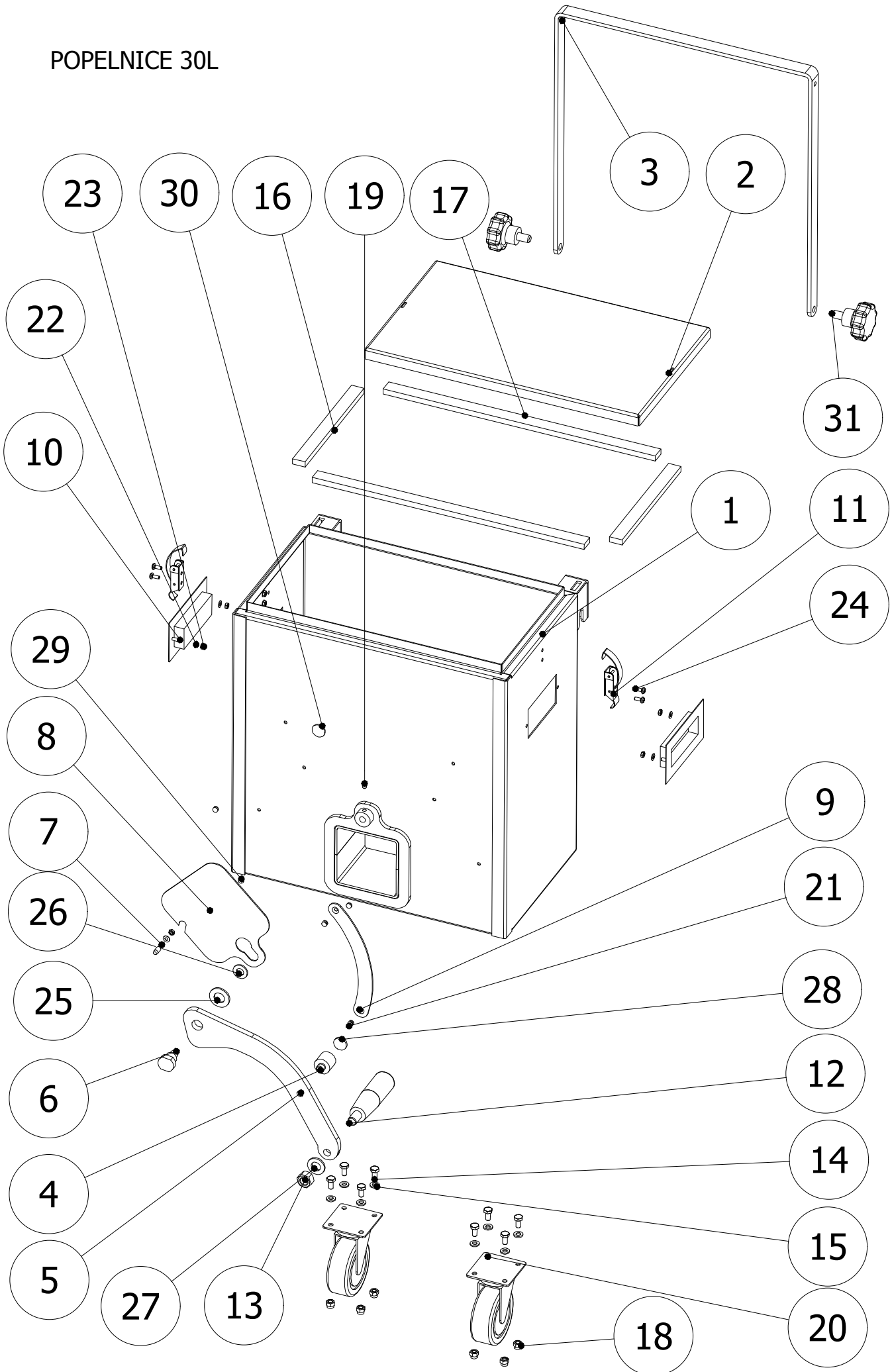

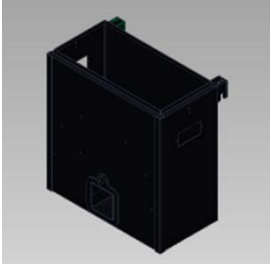
VYMETÁNÍ POPELE KP12	POZICE	POPIS	KÓD	ČÍSLO SOUČÁSTI	POČET KS	POZNÁMKY
	15	Kuličková ložiska jednořadá - 6204	MRUZ004 9	CSN 02 4630	2	

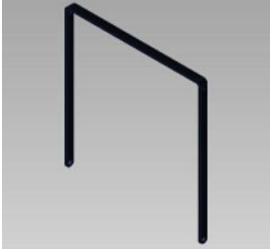
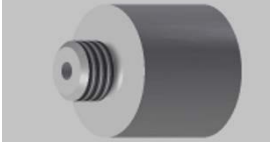
POPELNICE 30L

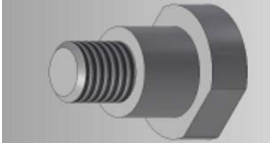

POPELNICE 30L	POZICE	POPIS	KÓD	ČÍSLO SOUČÁSTI	POČET KS	POZNÁMKY
	1	POPELNICE 30L KRABICE	PKTD0274	664.S01.000.A3	1	
	2	VÍKO	PKTB0281	664.S02.000.A3	1	
	3	DRŽADLO	PKTD0282	664.003.000.A3	1	
	4	DRŽÁK MAGNETICKÝ	PKTX0198	448.009.000.A4	1	
	5	PÁKA	PKTD0283	664.005.000.A3	1	
	6	ŠROUB	PKTX0197	448.006.000.A4	1	

POPELNICE 30L	POZICE	POPIS	KÓD	ČÍSLO SOUČÁSTI	POČET KS	POZNÁMKY
	7	DISTANCE	PKMX0037	054.009.003.A4	1	
	8	ZÁKLOPKA	MHVT0186	448.012.000.A4	1	
	9	DRÁHA	PKTX0284	664.010.000.A4	1	
	10	ÚCHYTKA ZAPUŠTĚNÁ UWAUNS	MRUZ0200	ÚCHYT	2	
	11	UZÁVĚR UP3	MRUZ0010		2	
	12	DLOUHÁ KUŽ. RUKOJEŤ	MRUZ0062	OBJ.Č.460650	1	

POPELNICE 30L	POZICE	POPIS	KÓD	ČÍSLO SOUČÁSTI	POČET KS	POZNÁMKY
	13	Šestihránné matice - M12	MSMX0007	ISO 4032	1	
	14	Šrouby se šestihránnou hlavou - M6 x 12	MSSX0083	ISO 4017	8	
	15	Ploché podložky - 6	MSPX0026	ISO 7089	8	
	16	TĚSNĚNÍ SILIKONOVÉ 8x18-190	MRUZ0090		2	
	17	TĚSNĚNÍ SILIKONOVÉ 8x18-386	MRUZ0201		2	
	18	Samojistné šestihránné matice - M6	MSMX0011	ISO 7041	8	

POPELNICE 30L	POZICE	POPIS	KÓD	ČÍSLO SOUČÁSTI	POČET KS	POZNÁMKY
	19	Stavěcí šrouby - M5 x 10	MSRX0015	ISO 4027	1	
	20	KOLO PEVNÉ EGA 075/FLP PR.75	MRUZ0056	FA.MONTAKO	2	
	21	Nýt se záp.hl. 4x8 Al	MSRX0064	DIN 660	2	
	22	Ploché podložky - 4	MSPX0014	ISO 7089	9	
	23	Šestihranné matice - M4	MSSX0012	ISO 4032	9	
	24	Šrouby s válcovitou hlavou5 - M4 x 10	MSSX0010	ISO 7045	4	



POPELNICE 30L	POZICE	POPIS	KÓD	ČÍSLO SOUČÁSTI	POČET KS	POZNÁMKY
	25	Ploché podložky - 14	MSPX0007	ISO 7089	1	
	26	Ploché podložky - 10	MSPX0005	ISO 7089	1	
	27	Ploché podložky - 12	MSPX0020	ISO 7089	1	
	28	MAGNET 18x3	MRUZ0088		1	
	29	Nýt trhací 4 x 8 Al	MSRX0013	DIN 660	3	
	30	MAGNET 18x2	MRUZ0077		1	

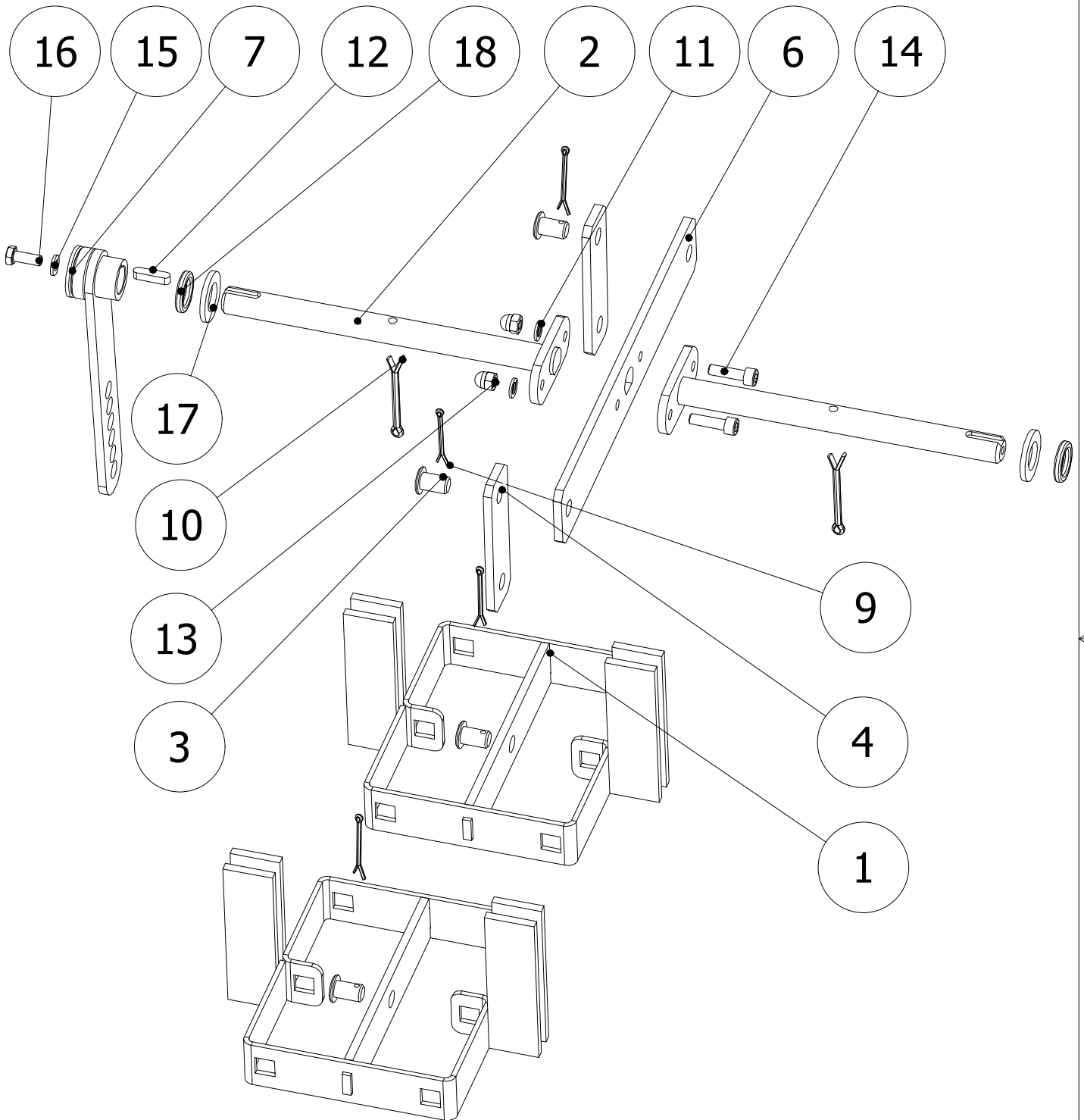

POPELNICE 30L	POZICE	POPIS	KÓD	ČÍSLO SOUČÁSTI	POČET KS	POZNÁMKY
	31	ŠROUB KOVOVÝ S PLAST.HLAVOU M10x17	MRUZ0032	OBJ.Č.105a- 068-D/MxL	2	

ČISTĚNÍ VÝMĚNÍKU

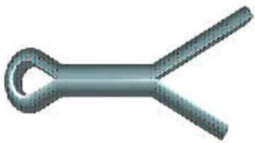
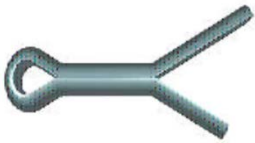

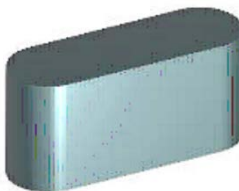
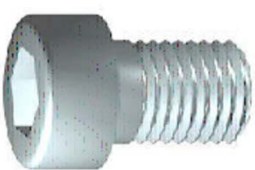
ČISTĚNÍ VÝMĚNÍKU	POZICE	POPIS	KÓD	ČÍSLO SOUČÁSTI	POČET KS	POZNÁMKY
	1	VAHADLO	PKTX0383	795.S01.000.A4	2	
	2	NÁSTAVEC	PKTX0384	795.S06.S00.A4	2	
	3	ČEP	PKTX0053	005.S16.007.A4	4	
	4	ZÁVĚS	PKTX0051	005.S16.004.A4	2	
	6	TÁHLO 2	PKTX0359	758.S06.A02.A4	1	
	7	RAMENO	PKTX0163	445.S08.000.A4	1	

ČISTĚNÍ VÝMĚNÍKU	POZICE	POPIS	KÓD	ČÍSLO SOUČÁSTI	POČET KS	POZNÁMKY
	9	Závlačka - 2,5 x 36	MSRX0048	ISO 1234	4	
	10	Závlačka - 4 x 50	MSRX0021	ISO 1234	2	
	11	Pružná podložka - A6	MSPX0019	DIN 128	2	
	12	Těsné pero - A 5 x 5 x 22	MSRX0006	DIN 6885	1	
	13	Šestihranná matice uzavřená - M6	MSMX0027	DIN 1587	2	
	14	Šrouby imbus - M6 x 22	MSSX0225	CSN 02 1143	2	

ČISTĚNÍ VÝMĚNÍKU	POZICE	POPIS	KÓD	ČÍSLO SOUČÁSTI	POČET KS	POZNÁMKY
	15	Ploché podložky - 6	MSPX0026	ISO 7089	1	Zn
	16	Šestihranný šroub - M6 x 16	MSSX0015	ISO 4017	1	Zn
	17	Podložka - A 17	MSPX0030	DIN 125	2	
	18	Šňůra těs. čišťění 4x4	PKTX0432		2	

MECHANISMUS ČISTĚNÍ

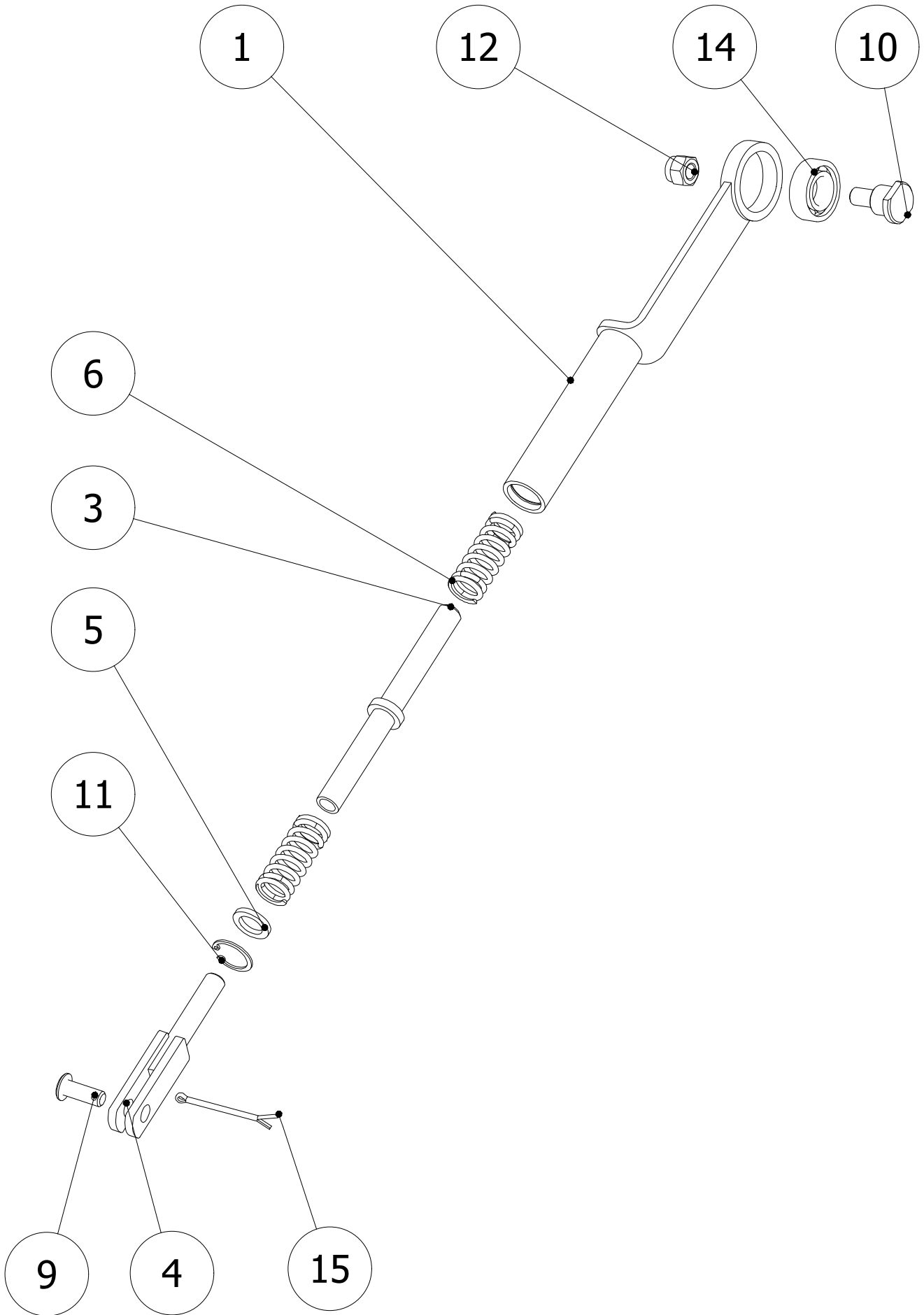

Mechanismus čišťení	POZICE	POPIS	KÓD	ČÍSLO SOUČÁSTI	POČET KS	POZNÁMKY
	1	ÓJE ČISTĚNÍ	PKTX0167	424.S01.000.A4	1	
	3	ČEP VEDENÍ	PKTX0170	424.003.000.A4	1	
	4	VIDLICE	PKTX0171	424.S04.000.A4	1	
	5	VÍČKO	MHVT0139	424.005.000.A4	1	
	6	PRUŽINA TLAČNÁ	MRUZ0065		2	
	9	ČEP 1	PKTX0175	424.009.000.A4	1	

Mechanismus čišění	POZICE	POPIS	KÓD	ČÍSLO SOUČÁSTI	POČET KS	POZNÁMKY
	10	ČEP	PKTX0176	424.010.000.A4	1	
	11	Pojistné kroužky pro díry - 22	MSRX0014	CSN 02 2931	1	
	12	Samojistné šestihřanné matice - M10	MSMX0006	ISO 7041	1	
	14	Kuličková ložiska jednořadá - 6003 2RS	MRUZ0048	CSN 02 4630	1	
	15	Závlačka - 3,2 x 50	MSRX0059	ISO 1234	1	

POHON VYMETÁNÍ

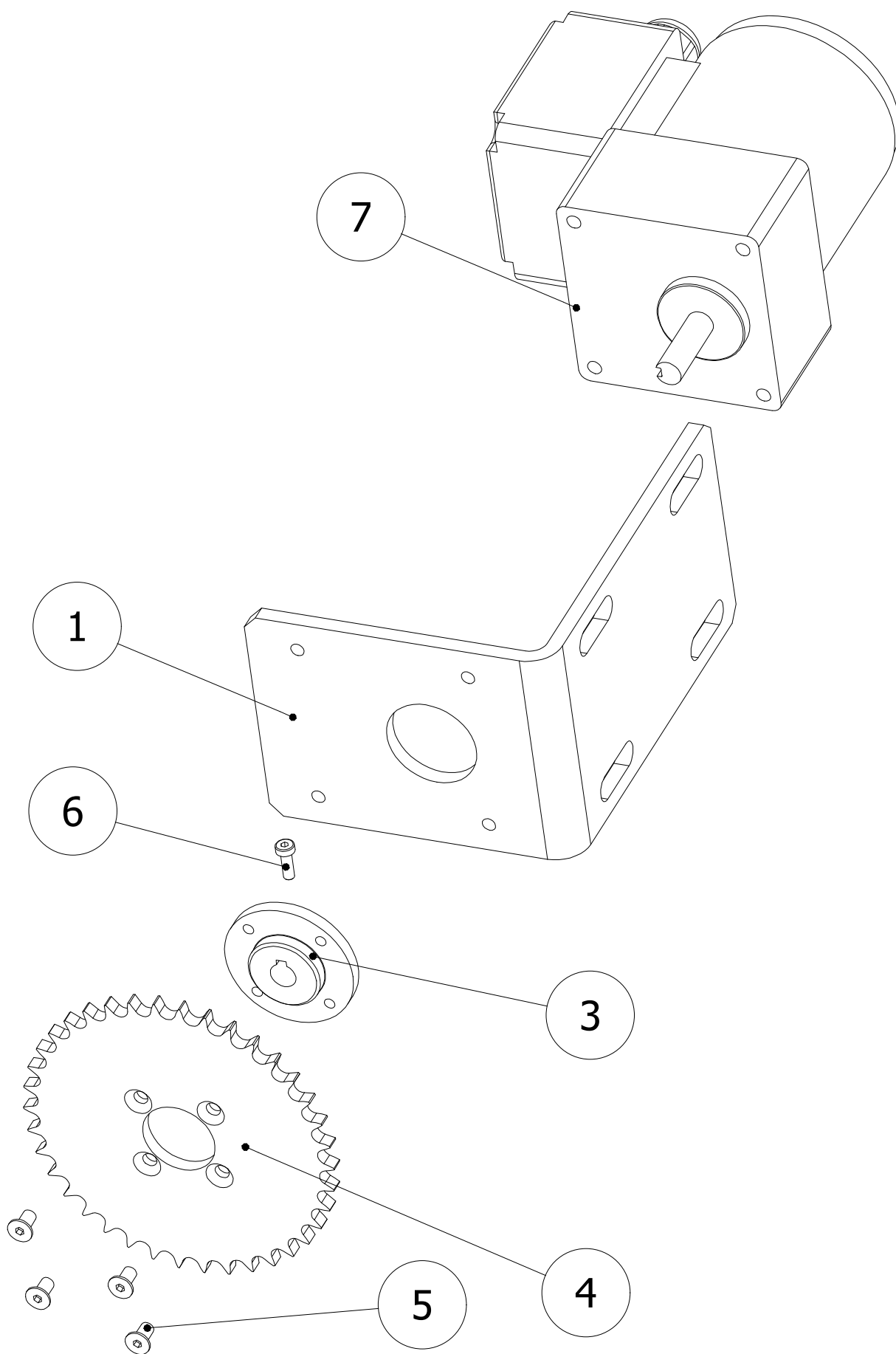

POHON VYMETÁNÍ	POZICE	POPIS	KÓD	ČÍSLO SOUČÁSTI	POČET KS	POZNÁMKY
	1	KONZOLA	PKTX0177	336.001.000.A3	1	
	3	NÁBOJ	PKTX0180	336.002.000.A4	1	
	4	KOLO ŘETĚZOVÉ 2 ÚPRAVA	PKTX0181	336.003.000.A4	1	
	5	Šroub se zápustnou hlavou - M5 x 10	MSSX0026	ISO 1064	4	
	6	Šroub s válcovou hlavou - M4 x 12	MSSX0090	DIN 7984	1	
	7	DKM MOTOR S PŘEVODOVKOU U MOTOR 8RDGE-25G-T- 8GBK50BHM	MEMPO02 6		1	
	8	Řetěz vál. Jedn. 103 čl. 06 B-1 (3,8x7,32)	MRUZ014 1		1	

POHON VYMETÁNÍ	POZICE	POPIS	KÓD	ČÍSLO SOUČÁSTI	POČET KS	POZNÁMKY
	9	Článek spojovací jednoř.	MRUZ004 1		1	

POHON ČISTĚNÍ TAHŮ

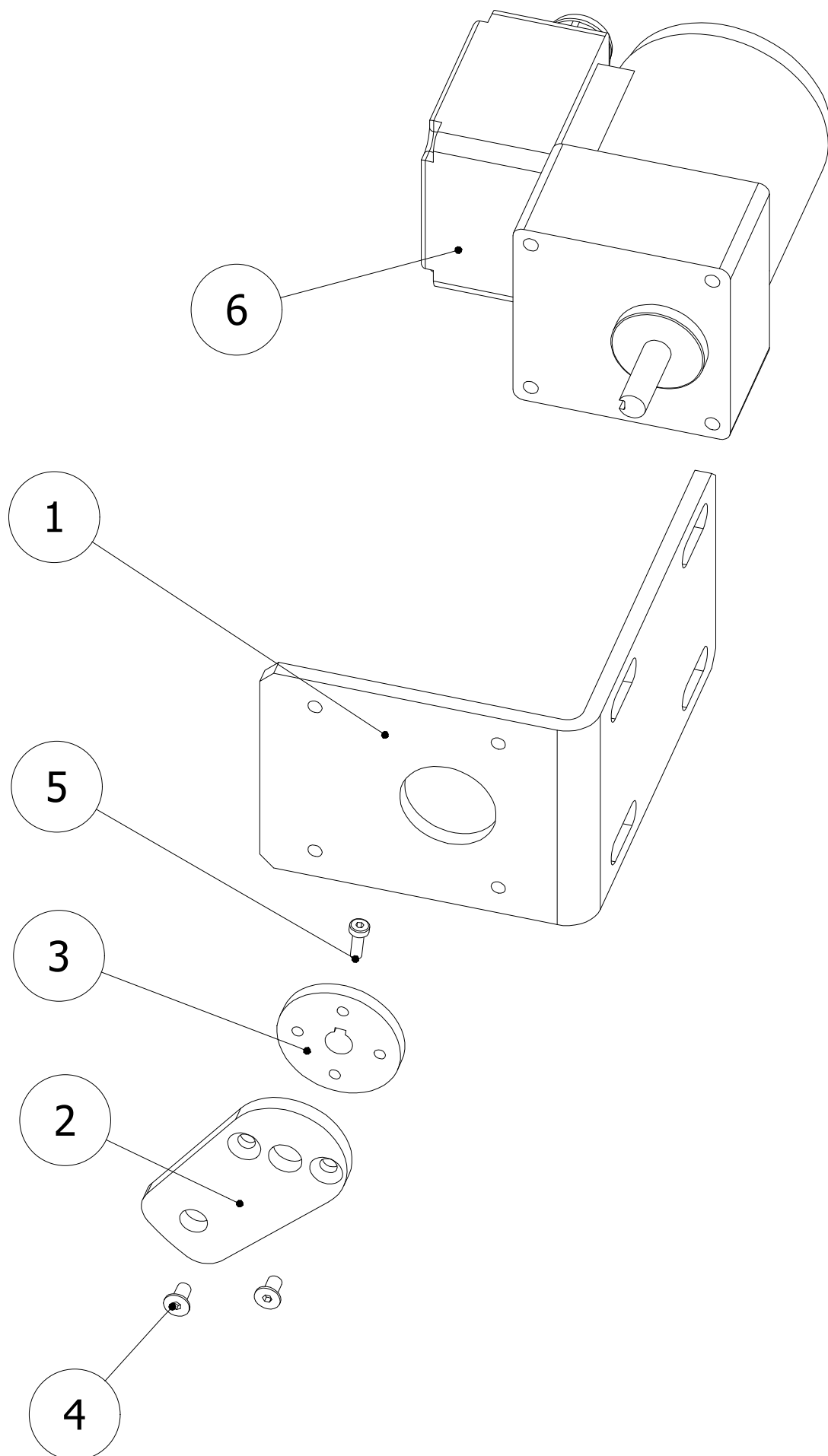

POHON ČISTĚNÍ TAHŮ	POZICE	POPIS	KÓD	ČÍSLO SOUČÁSTI	POČET KS	POZNÁMKY
	1	KONZOLA	PKTX0177	336.001.000.A3	1	
	2	PÁKA	PKTX0179	397.S25.003.A4	1	
	3	NÁBOJ	PKTX0178	374.S18.002.A4	1	
	4	Šroub se zápustnou hlavou - M5 x 10	MSSX0026	ISO 10642	2	
	5	Šroub s válcovou hlavou - M4 x 12	MSSX0090	DIN 7984	1	
	6	DKM MOTOR S PŘEVODOVKO U MOTOR 8RDGE-25G-T- 8GBK50BHM	MEMPO02 6		1	

ELEKTRO

KÓD	POPIS	MNOŽSTVÍ
MEKV0003	Kabel SIHF 3G 1	3,44 m
MEKV0006	Kabel H07 V-K 2.5 zž.	0,176 m
MEKV0037	Kabel H07V-K 1,5 zž	3,0 m
MEKV0047	Šňůra FLEX H05VV-F 3x1,5 5m	1,0 ks
MEKV0065	Kabel LiYY 4x0,14	5,0 m
MEKV0070	Kabel H05VV-F 4G1,5B	3,5 m
MEKV0071	Kabel H07V-K 1,5 sv.modr	2,5 m
MEKV0072	Kabel H07V-K 1,5 černý	3,0 m
MERX0003	Objímka plochá BF-F 608P	8,0 ks
MERX0004	Dutinka lis. DI 1.0-10 10	37,0 ks
MERX0016	Svorka WAGO 222-413	4,0 ks
MERX0020	Canon 9 V (RKP 12157)	1,0 ks
MERX0027	Trubička smršť. 3,2/1,6 SB/PBF-1/8	0,05 m
MERX0030	Objímka plochá RF-F 608P	3,0 ks
MERX0043	Canon sada matic CTB	1,0 ks
MERX0051	Vývodka PG 9 s matkou	16,0 ks
MERX0067	Přichytka PKB-BS 27x27mm přírodní samolepící	3,0 ks
MERX0073	Svorka WAGO 222-415	1,0 ks
MERX0078	Štítek uzemění malý /baleno po 40 ks/	4,0 ks
MERX0126	Okolo lisovací RF-M4	6,0 ks
MERX0151	Spirála svazková SPC10	1,0 m
MERX0158	Pásek vázací 200/3,6	8,0 ks
MERX0205	Vývodka PG 7	9,0 ks
MERX0221	Kolík ploch.přístroj. SEZC7202-00/4/100	4,0 ks
MERX0237	Konektor RJ 45-8/8 C5 dr vidlice	1,0 ks
MERX0282	Konektor RJ 45-8 Cat.5e UTP	1,0 ks
MERX0529	Kolík dvojitý 7242-00/5/4	1,0 ks
MERX0581	Filtr odrušovací MIFLEX FP-250/16	1,0 ks
MERX0621	Matka Pg 7 sv. šedá	9,0 ks
MERX0631	Konektor 2,5 / 3 green SIGMATEK	16,0 ks
MERX0632	Konektor 1,5 / 2 green SIGMATEK	15,0 ks
MERX0633	Konektor 2,5 / 2 green SIGMATEK	1,0 ks
MERX0634	Konektor 2,5 / 4 green SIGMATEK	4,0 ks
MERX0635	Konektor 1,5 / 4 green SIGMATEK	1,0 ks
MERX0636	Konektor 1,5 / 3 green SIGMATEK	1,0 ks
MERX0641	Kryt P - Canon 9	1,0 ks
MERX0648	Spirála svazková SPC15	0,5 m
MERX0661	Buž. smršť. SB 3,2/1,6 Mo modrá	0,06 m
MERX0662	Zástrčka ST18 -3 pol.č. Wieland	1,0 ks
METR0071	Deska základní HZS 521-G	1,0 ks
METR0072	Modul expandér HZS 532-1	1,0 ks
METR0083	Snímač teploty příložený KS 154A KTY 81-110, 3,5m	2,0 ks
METR0085	Snímač teploty TG8-55 KTY 81-110, 1,5m voda	1,0 ks
METR0087	Snímač teploty pro ven. KS 114B, KTY 81-110	1,0 ks
METR0108	Snímač teploty TR 050J-x TCK,silicon zelený 1,4m	1,0 ks
MREZ0012	Etiketa stříbrná 210x297 baleno po 20 ks	1,0 ks
MRUZ0211	FlaschDisk USB 2,0 Sandisk Cruiser Fit 8GB	1,0 ks

KÓD	POPIS	MNOŽSTVÍ
MRUZ0219	Průchodka 24,9 x 1,6 Moss 11214	1,0 ks
MRUZ0220	Podložka tlum. 10x10x2,5 čtvercová 35604-0	2,0 ks
MRUZ0272	Zátka antivibrační 1/2 BSP - velikost 8	1,0 ks
MRUZ0274	Zátka souběžná 46.1MM č.465668	2,0 ks
MRUZ0275	Fólie laminovací A4	1,0 ks
MTBX0033	Páska oboustranně lepící š.=15mm	0,02 ks
PHXX0215	Kabel 0,75 pro DKM	2,0 ks
PKEX0036	Kabeláž KP 12S - 2 m	1,0 ks

PONAST spol. s r.o
Na Potůčkách 163
757 01 Valašské Meziříčí

ČESKÁ REPUBLIKA

www.ponast.cz

tel.: 571 688 111*, 800 700 068

e-mail: servis@ponast.cz