



katalog náhradních dílů
automatického kotle
KP 52S



PONAST spol. s r.o
Na Potůčkách 163
757 01 Valašské Meziříčí
ČESKÁ REPUBLIKA
tel.: 571 688111*
e-mail: ponast@ponast.cz

aktualizace: 05/12/2018



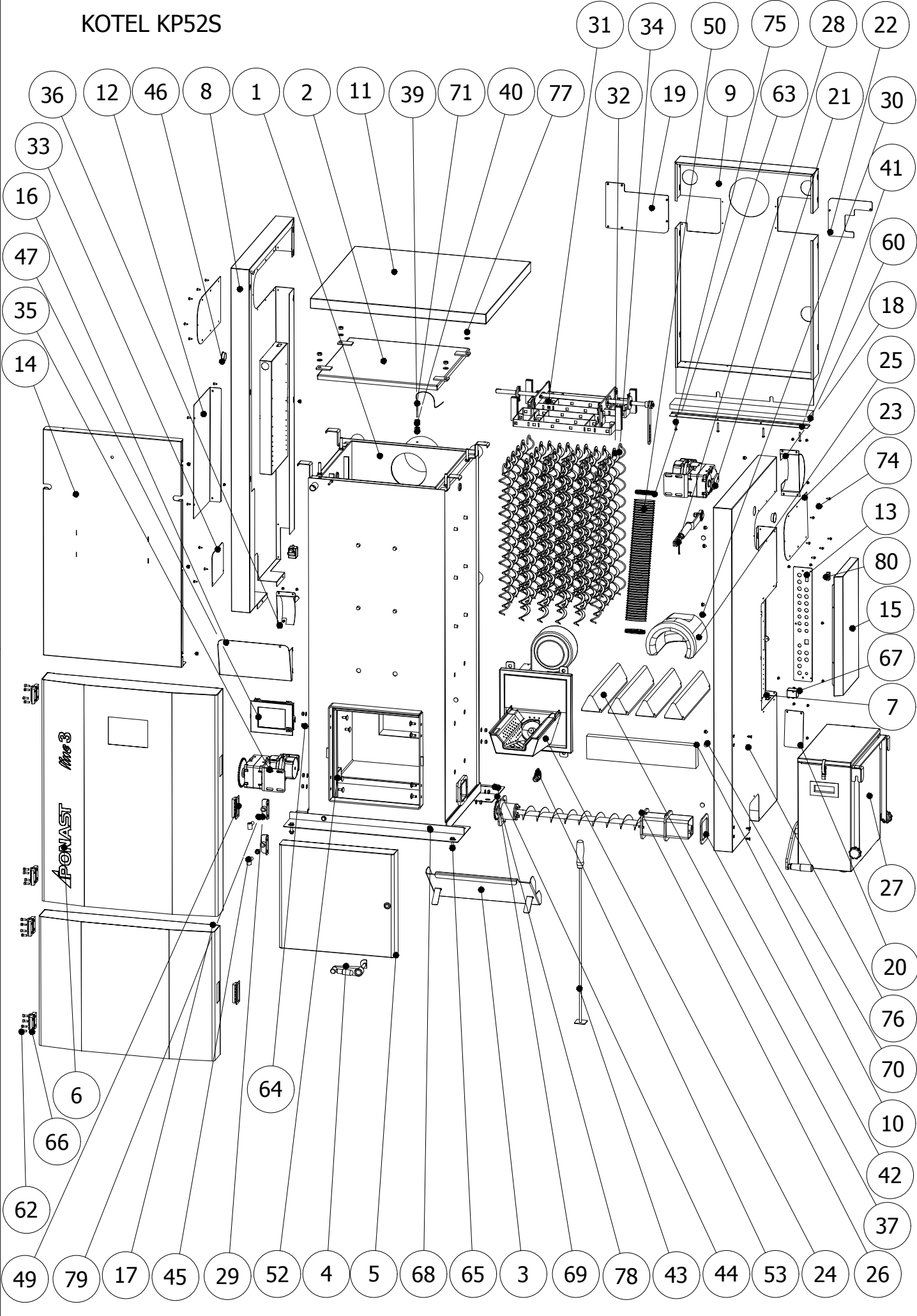

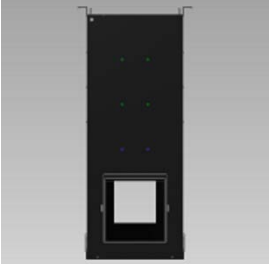
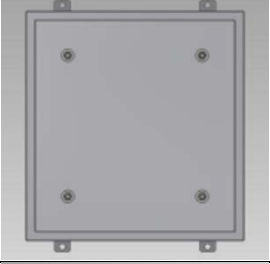
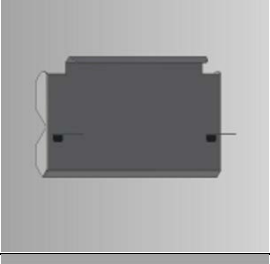

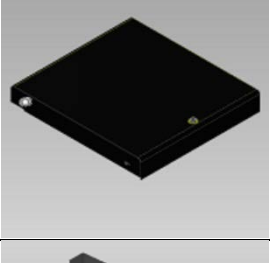
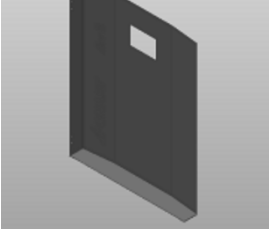
KOTEL KP52S

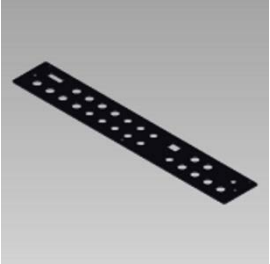
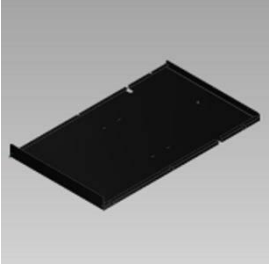

KOTEL KP52S	POZICE	POPIS	KÓD	ČÍSLO SOUČÁSTI	POČET KS	POZNÁMKY
	1	KOTLOVÉ TĚLESO KP52S	PKXX5201	764.S01.000.A1	1	Sestava
	2	VÍKO	KKTX0011	005.S02.000.A2	1	Sestava
	3	LOPATKA KP52S	PKTX0443	764.S09.000.A3	1	
	4	KLIKA x2	KKTX0019	338.S04.000.A3	1	Sestava
	5	DVÍŘKA	KKTX0029	397.S05.000.A2	1	Sestava
	6	ČELO KP52S	PKMBB0207	764.S03.000.A3	1	

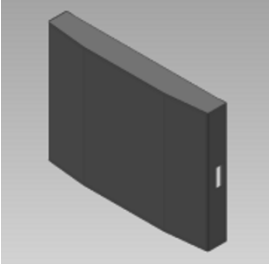
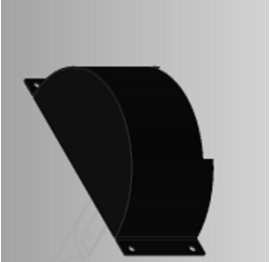
KOTEL KP52S	POZICE	POPIS	KÓD	ČÍSLO SOUČÁSTI	POČET KS	POZNÁMKY
	7	BOČNICE PRAVÁ	PKMD0214	764.S07.000.A3	1	
	8	BOČNICE LEVÁ	PKMD0211	764.S06.000.A3	1	
	9	KRYT ZADNÍ	PKMD0216	764.010.000.A3	1	
	10	KERAMIKA NAD DV.KP50-62	MTKE0001	338.053.000.A4	1	
	11	VÍKO HORNÍ- SVAŘENEC	PKMBB0164	723.S05.000.A4	1	
	12	KRYT KRABICE	PKMD0168	723.008.000.A3	1	

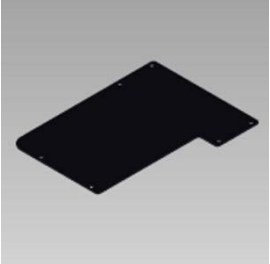
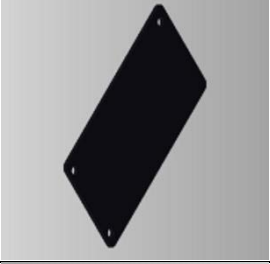
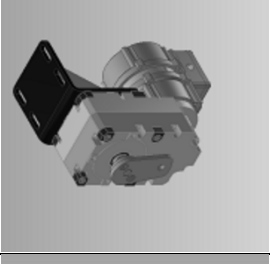
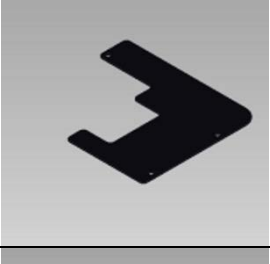
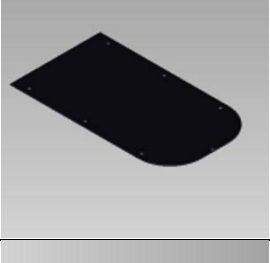
KOTEL KP52S	POZICE	POPIS	KÓD	ČÍSLO SOUČÁSTI	POČET KS	POZNÁMKY
	13	DESKA	PKMD0143	723.005.000.A4	1	
	14	VZPĚRA 1	PKMD0213	764.006.000.A4	1	
	15	KRYT JEDNOTKY BOČNÍ	PKMD0142	726.008.000.A3	1	
	16	ŠUPLÍK	PKMD0169	723.010.000.A3	1	
	17	KRYT DVEŘÍ KP52S	PKMBB0209	764.S04.000.A3	1	
	18	KRYT ČISTĚNÍ	PKMD0081	397.S13.000.A3	1	

KOTEL KP52S	POZICE	POPIS	KÓD	ČÍSLO SOUČÁSTI	POČET KS	POZNÁMKY
	19	KRYTKA OTVORU MOTORU	PKMD0104	338.S06.002.A4	1	
	20	PLECH KRYCÍ	PKMD0074	397.S07.009.A4	1	
	21	POHON ČISTĚNÍ TAHŮ	KKTX0041	727.S25.000.A3	1	Sestava
	22	KRYTKA ZAD	PKMD0102	338.S07.007.A4	1	
	23	KRYTKA POHONU ČISTĚNÍ	PKMD0071	397.S07.006.A3	2	
	24	HOŘÁK KP51 L EPO	KHXX5124	523.V14.000.A3	1	Sestava

KOTEL KP52S	POZICE	POPIS	KÓD	ČÍSLO SOUČÁSTI	POČET KS	POZNÁMKY
	25	REFLEKTOR KERAMICKÝ	MTKE0020	001.042.000.A3	1	
	26	VYMET.POPELE KP52S	KKTX0059	764.S08.000.A2	1	Sestava
	27	POPELNICE 45L	KKTI0045 KKTI0027	568.000.000.A3	1	Sestava PRAVÁ LEVÁ
	28	MECHANISMUS ČISTĚNÍ	KKTX0024	424.000.000.A3	1	Sestava
	29	PANT DÍL 2	PKTX0134	397.S01.S43.A3	2	
	30	KLÍČ	PKRX0008	286.000.000.A4	14	

KOTEL KP52S	POZICE	POPIS	KÓD	ČÍSLO SOUČÁSTI	POČET KS	POZNÁMKY
	31	ČISTĚNÍ VÝMĚNÍKU KP52	KKTX0064	797.000.000.A3	1	Sestava
	32	TURBULÁTOR PLOCHÝ 645mm	MRUZ0027	005.014.000.A4	32	
	33	KRYTKA POHONU VYMETÁNÍ 1	PKMD0105	338.S06.005.A3	1	
	34	TURBULÁTOR KRUH. 645mm	MRUZ0026	005.021.000.A4	4	
	35	POHON VYMETÁNÍ	KKTX0057	397.S24.000.A3	1	Sestava
	36	KRYT VYMETÁNÍ L+P	PKMD0062 PKMD0083	397.S14.000.A3	1	PRAVÝ LEVÝ



KOTEL KP52S	POZICE	POPIS	KÓD	ČÍSLO SOUČÁSTI	POČET KS	POZNÁMKY
	37	KERAMIKA TROJÚHELNÍKOVÁ	MTKE0135	420.900.000.A3	4	
	39	REDUKCE DÍL 1	PKRX0062	792.001.000.A4	1	
	40	REDUKCE DÍL 2	PKRX0063	792.002.000.A4	1	
	41	DRŽÁK SIBRALU	PKMD0120	338.056.000.A4	1	
	42	TĚSNĚNÍ	PKTX0157	334.S08.005.A4	1	
	43	ŠKRABKA	PKRX0001	001.S32.000.A4	1	

KOTEL KP52S	POZICE	POPIS	KÓD	ČÍSLO SOUČÁSTI	POČET KS	POZNÁMKY
	44	DRŽÁK KOTLE KP50,51	PKRX0046	356.000.000.A3	2	
	45	PANT DVÍŘEK	PKTX0121	054.S05.S03.A4	2	
	46	ZÁSLEPKA ČERNÁ 35-38mm	MRUZ0228		2	
	47	TERMINÁL DOTYKOVÝ HZS 555-S	METR0073		1	
	48	Vějířová pojistná podložka - A 10,5	MSPX0003	DIN 6798	4	
	49	Rukojeť EPR_90_Pf_C1	MRUZ0205		2	

KOTEL KP52S	POZICE	POPIS	KÓD	ČÍSLO SOUČÁSTI	POČET KS	POZNÁMKY
	50	HADICE FLEXADUR PU-1NO DN 80x1000	MRUZ0018		1	
	52	Šroub s půlk. hl.a 4hr.kr. - M8 x 20	MSSX0207	DIN 603	8	
	53	VENTIL VYPOŠTĚCÍ S PÁČKOU	MRUZ0024		1	
	60	SIBREX 300 20x80x594	MTIZ0018		1	
	62	Šroub s válcovou hlavou - M6 x 16	MSSX0224	DIN 912	16	
	63	SPONA HADICOVÁ 70-90 NEREZ	MRUZ0089		2	

KOTEL KP52S	POZICE	POPIS	KÓD	ČÍSLO SOUČÁSTI	POČET KS	POZNÁMKY
	64	Podložka - A 8,4	MSPX0001	DIN 125	24	
	65	Šestihranný šroub - M8 x 40	MSSX0027	DIN 933	4	
	66	Pant ELESA CFA.65-SL-H-V	PKTX0295		4	
	67	HAVARIJNÍ TERMOSTAT LY 26 I	METR0049		2	
	68	Šestihranný šroub - M8 x 20	MSSX0002	DIN 933	4	
	69	Šestihranná matice - M8	MSMX0016	DIN 934	28	

KOTEL KP52S	POZICE	POPIS	KÓD	ČÍSLO SOUČÁSTI	POČET KS	POZNÁMKY
	70	MAGNET 18x2	MRUZ0077		4	
	71	Snímač teploty TR 050J-x TCK, 1,4m	METRO108		1	
	72	SIBREX 300 20x115x365	MTIZ0009		1	
	74	Šrouby samořezné - ST 4,8 x 13	MSSX0118	ISO 7049	45	
	75	Šroub do plechu - ST4,8 x 38	MSSX0042	ISO 7049	4	
	76	Nýt zarážecí pr.5mm 27024050	MSSX0125		4	

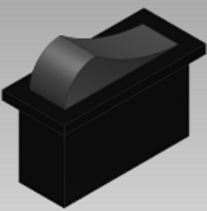
KOTEL KP52S	POZICE	POPIS	KÓD	ČÍSLO SOUČÁSTI	POČET KS	POZNÁMKY
	77	Šestihránná matice - M10	MSMX0002	DIN 934	12	
	78	Podložka - A 10,5	MSPX0005	DIN 125	20	
	79	Šestihránné matice - M12	MSMX0007	ISO 4032	2	
	80	Vypínač SSk 315 RED	MERX0579		1	

TĚLESO KOTLOVÉ KP52S

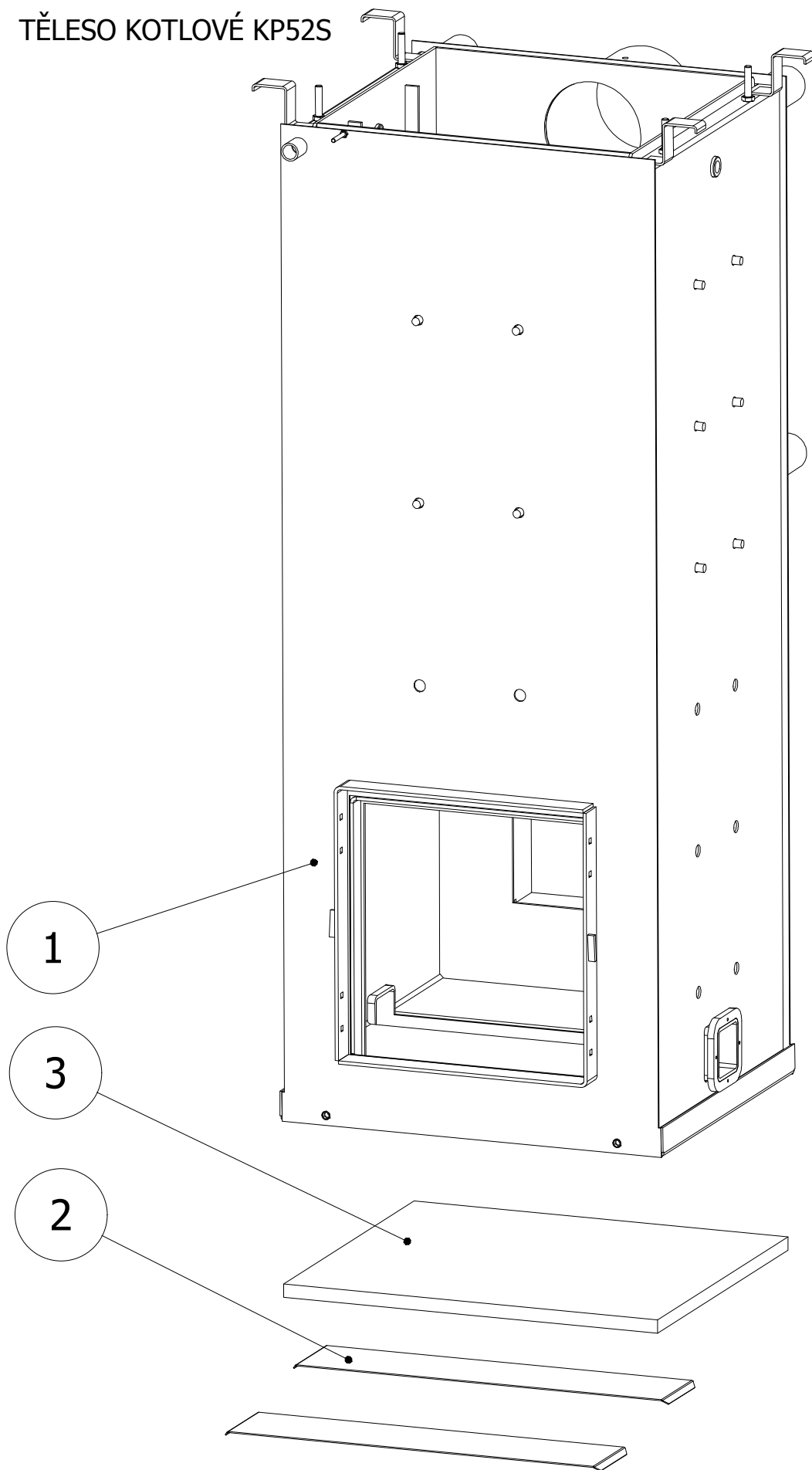

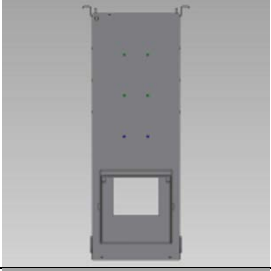
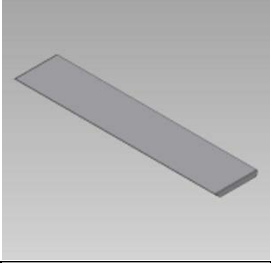
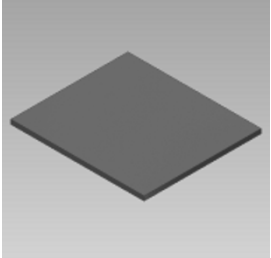
TĚLESO KOTLOÉ KP52S	POZICE	POPIS	KÓD	ČÍSLO SOUČÁSTI	POČET KS	POZNÁMKY
	1	TĚLESO KOTLOVÉ KP52S	PKXX5201	764.S01.000.A1	1	
	2	DRŽÁK IZOLACE KP51, KP82	PKTX0348	PKTX0348	2	
	3	IZOLACE 20x515x586	PKTX0344		1	

VÍKO

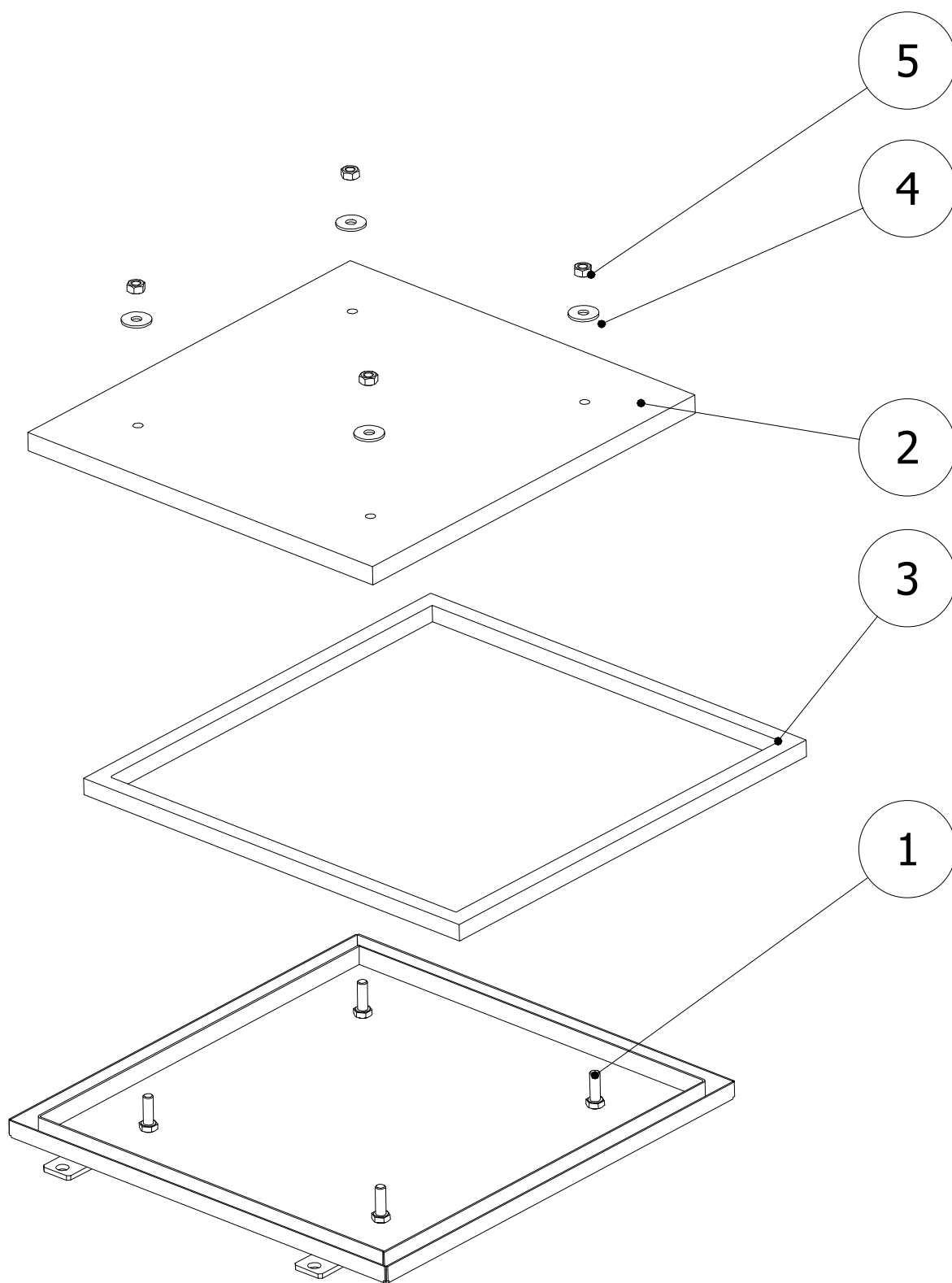

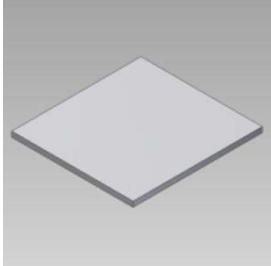
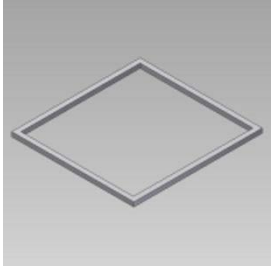
VÍKO	POZICE	POPIS	KÓD	ČÍSLO SOUČÁSTI	POČET KS	POZNÁMKY
	1	VÍKO KOTL.TĚLESA KP50,51	PKTX0100	005.002.000.A2	1	
	2	SIBREX 140 20x446x475	MTIZ0001		1	
	3	ŠŇŮRA VÍKA 18x18	MRUZ0133		1.52m	
	4	Podložka - 10,5	MSPX0004	DIN 9021	4	
	5	Šestihranné matice - M10	MSMX0002	ISO 4032	4	

KLIKA

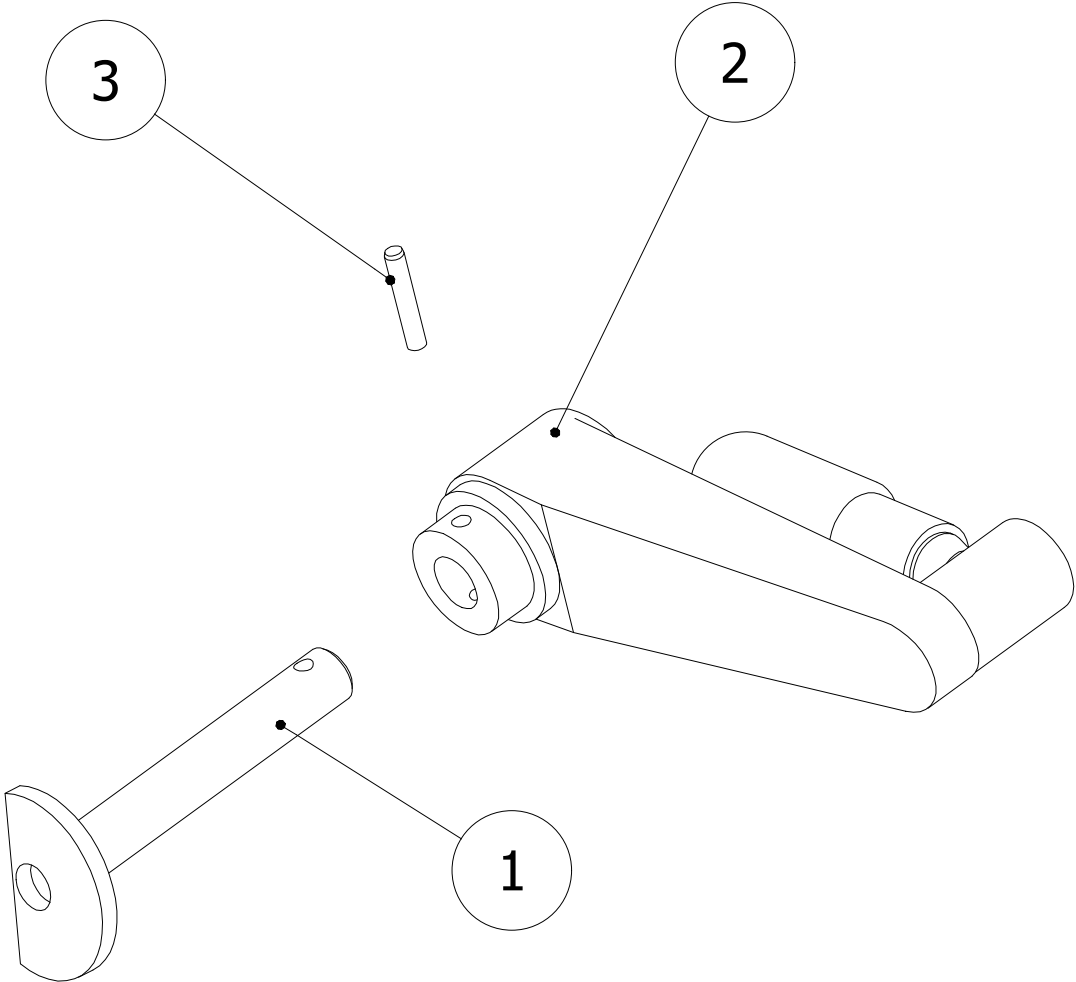

KLIIKA	POZICE	POPIS	KÓD	ČÍSLO SOUČÁSTI	POČET KS	POZNÁMKY
	1	DŘÍK KLIKY	PKTX0118	054.S04.001.A3	1	
	2	KLIIKA SKLAPOVACÍ ELESA GANTER	MRUZ0117	MT.100-AT+IR	1	KÓD 44317
	3	Kolík - 4 x 24 - A (kalený)	MSRX0003	ISO 8734	1	

DVÍŘKA

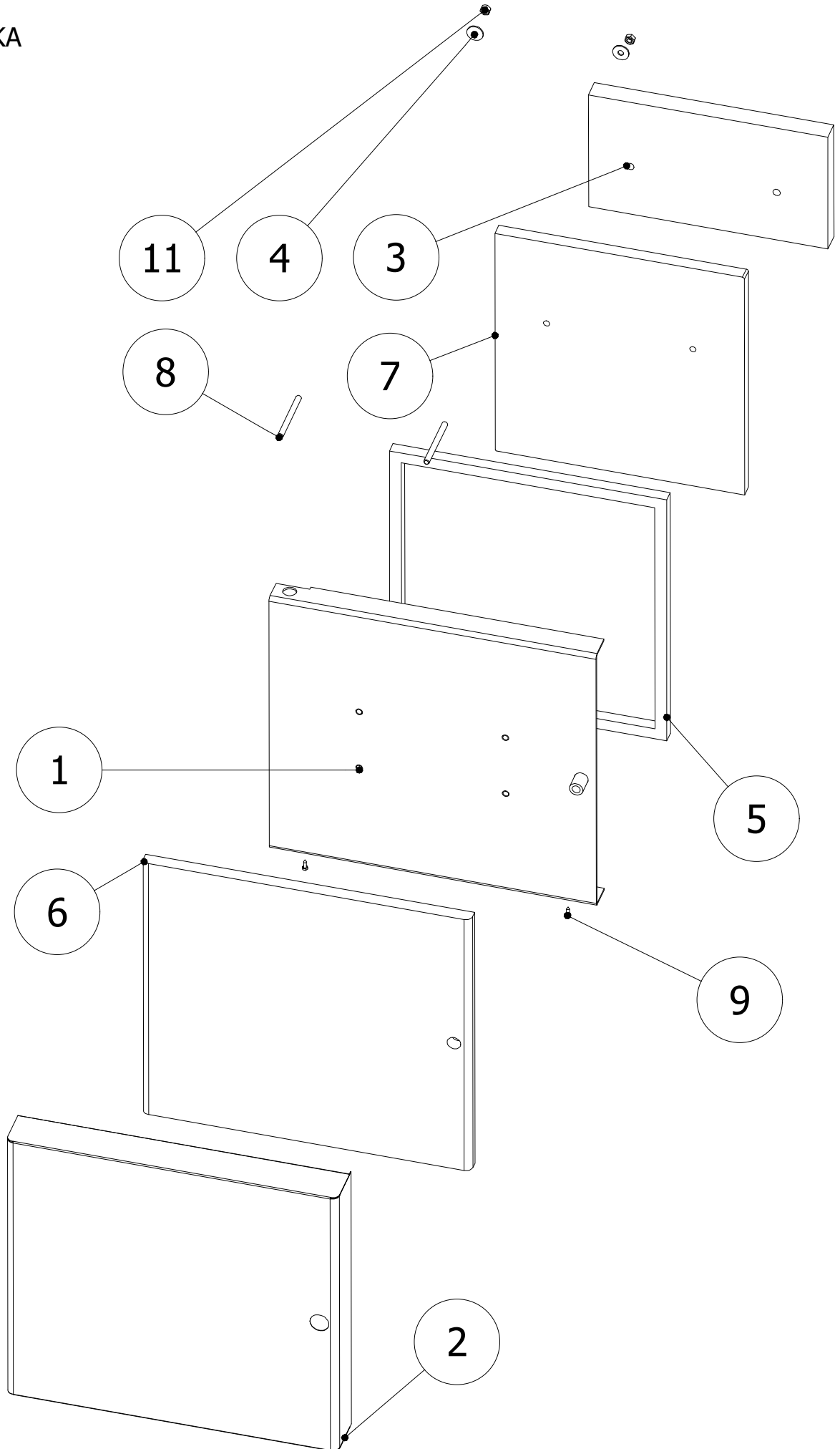

DVÍŘKA	POZICE	POPIS	KÓD	ČÍSLO SOUČÁSTI	POČET KS	POZNÁMKY
	1	DVÍŘKA KP22	PKTX0211	397.005.000.A3	1	
	2	KRYT DVÍŘEK	PKMD0090	397.012.000.A3	1	
	3	KERAMIKA NA DVÍŘKA	MTKE0004	001.005.008.A4	1	
	4	Podložka - 8,4	MSPX0008	DIN 9021	2	
	5	TĚSN. ŠŇŮRA 18x18	MRUZ0133		1.62m	
	6	IZOLACE DVÍŘEK 20x469x449	MTIZ0011		1	

DVÍŘKA	POZICE	POPIS	KÓD	ČÍSLO SOUČÁSTI	POČET KS	POZNÁMKY
	7	IZOLACE TĚLA 20x388x370	MTIZ0005		1	
	8	TYČ ZÁVITOVÁ M8x95	PKTX0117		2	
	9	Šroub do plechu - ST4,2 x 13	MSSX0012	ISO 1479	2	
	10	NÝT 10x50 Fe	MSRX0032	DIN 660	2	
	11	Šestihenné matice - M8	MSMX0016	ISO 4032	2	

POHON ČISTĚNÍ

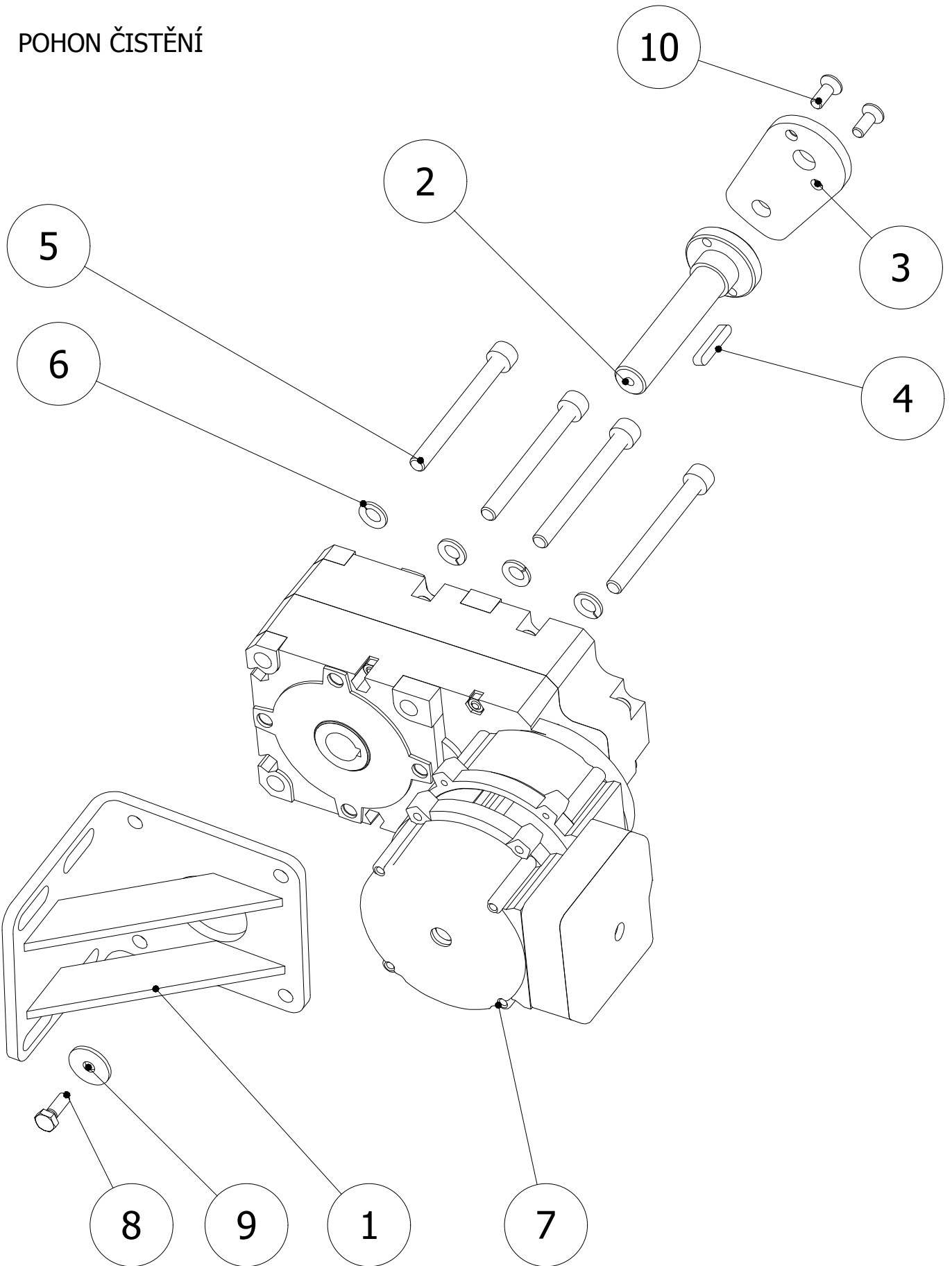

POHON ČISTĚNÍ TAHŮ	POZICE	POPIS	KÓD	ČÍSLO SOUČÁSTI	POČET KS	POZNÁMKY
	1	DRŽÁK MOTORU ABM	PKTX0216	446.S01.000.A3	1	
	2	UNAŠEČ	PKTX0218	446.002.000.A3	1	
	3	PÁKA	PKTX0179	397.S25.003.A4	1	
	4	Těsné pero - A 5 x 5 x 30	MSRX0007	DIN 6885	1	
	5	Šroub s válcovou hlavou - M8 x 80	MSSX0045	DIN 912	4	
	6	Pružná podložka - A8	MSPX0006	DIN 128	4	

POHON ČISTĚNÍ TAHŮ	POZICE	POPIS	KÓD	ČÍSLO SOUČÁSTI	POČET KS	POZNÁMKY
	7	Motor EPO MRB 0,12kW/2p	MEMP0037		1	
	8	Šestihranný šroub - M6 x 16	MSSX0015	DIN 933	1	
	9	Podložka 6	MSPX0002	DIN 440R	1	
	10	Šroub se zápusťnou hlavou - M6 x 16	MSSX0096	DIN 7991	2	
	11	Kabel SIHF 3G 1	MEKV0003		1.5m	

HOŘÁK KP51 EPO MEVE0017

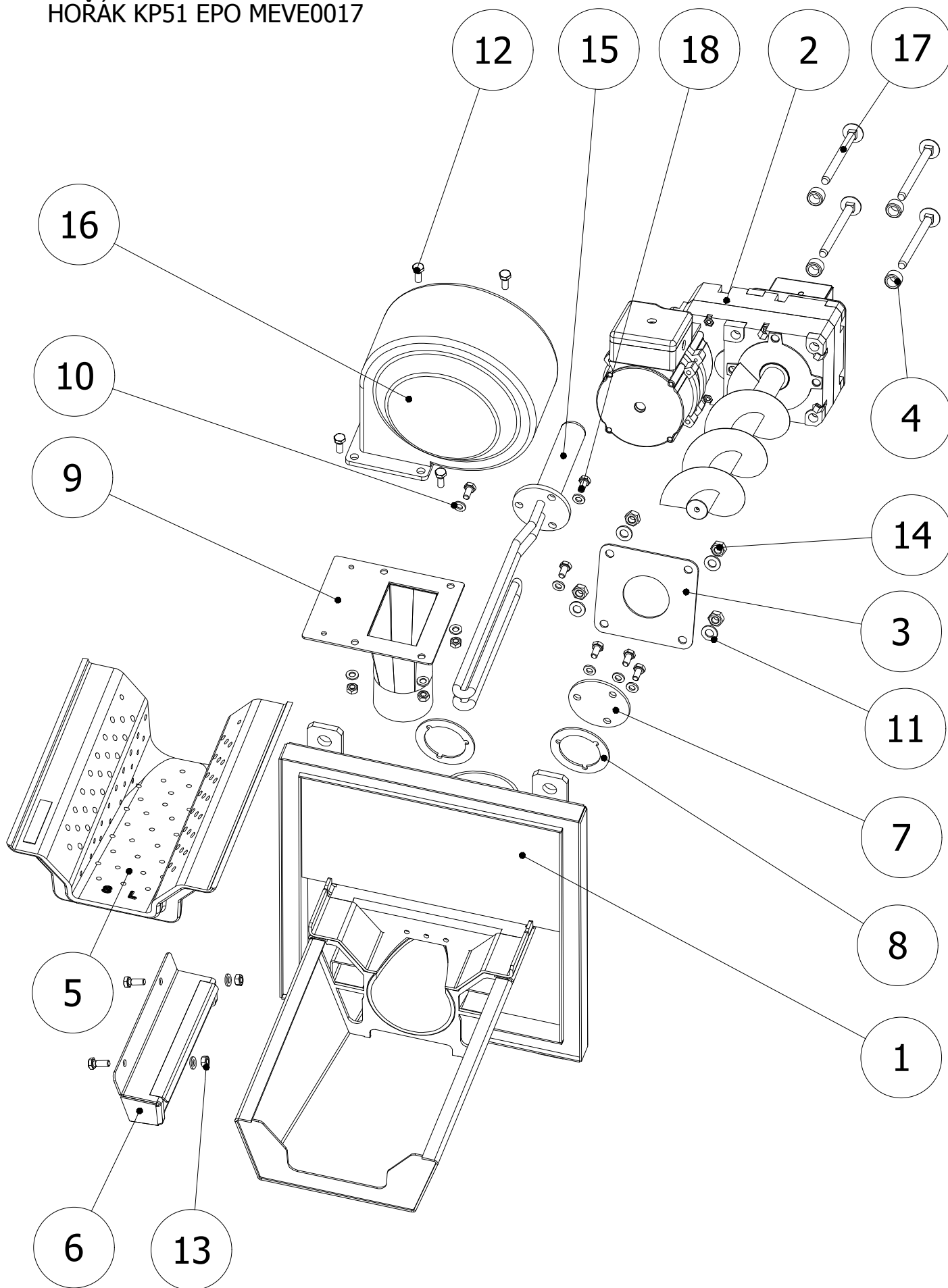



HOŘÁK KP51 EPO MEVE0017	POZICE	POPIS	KÓD	ČÍSLO SOUČÁSTI	POČET KS	POZNÁMKY
	1	HOŘÁK KP51 SVAŘENEC+TĚSNĚNÍ+SIBREX	KHXX5102	523.001.000.A3	1	Sestava
	2	PODAVAČ P2 EPO 2013	KHXX5125	523.S21.000.A3	1	Sestava
	3	MEZIKUS PRO EPOMOTORY 2013	PHXX0161	428.300.000.A4	1	
	4	DISTANCE DRŽÁKU SNÍMAČE	PHXX0162	428.400.000.A4	4	
	5	DESKA HOŘÁKOVÁ KP51	MHRX0052	523.050.000.A3	1	
	6	TUNEL	PHXX0062	523.014.000.A3	1	

HOŘÁK KP51 EPO MEVE0017	POZICE	POPIS	KÓD	ČÍSLO SOUČÁSTI	POČET KS	POZNÁMKY
	7	VÍČKO	PHXX0113	116.018.000.A4	1	
	8	TĚSNĚNÍ	PHXX0115	493.021.000.A4	2	
	9	NÁDSTAVBA VENTILÁTORU	PKRX0028	363.000.000.A3	1	
	10	Ploché podložky - 6	MSPX0026	ISO 7089	12	
	11	Ploché podložky - 8	MSPX0001	ISO 7089	4	
	12	Šestihranný šroub - M6 x 16	MSSX0015	DIN 933	6	

HOŘÁK KP51 EPO MEVE0017	POZICE	POPIS	KÓD	ČÍSLO SOUČÁSTI	POČET KS	POZNÁMKY
	13	Šestihhranné matice - M6	MSMX0001	ISO 4032	6	
	14	Šestihhranné matice - M8	MSMX0016	ISO 4032	4	
	15	SPIRÁLA ZAPALOVACÍ 1000W ZALOM.	MERX0139		1	
	16	VENTILÁTOR RG12S-2EP	MEVE0017		1	
	17	Šroub s půlk.hl.a 4rh.krčkem - M8 x 100	MSSX0129	DIN 603	4	
	18	Šrouby se šestihhrannou hlavou - M6 x 12	MSSX0083	ISO 4017	6	

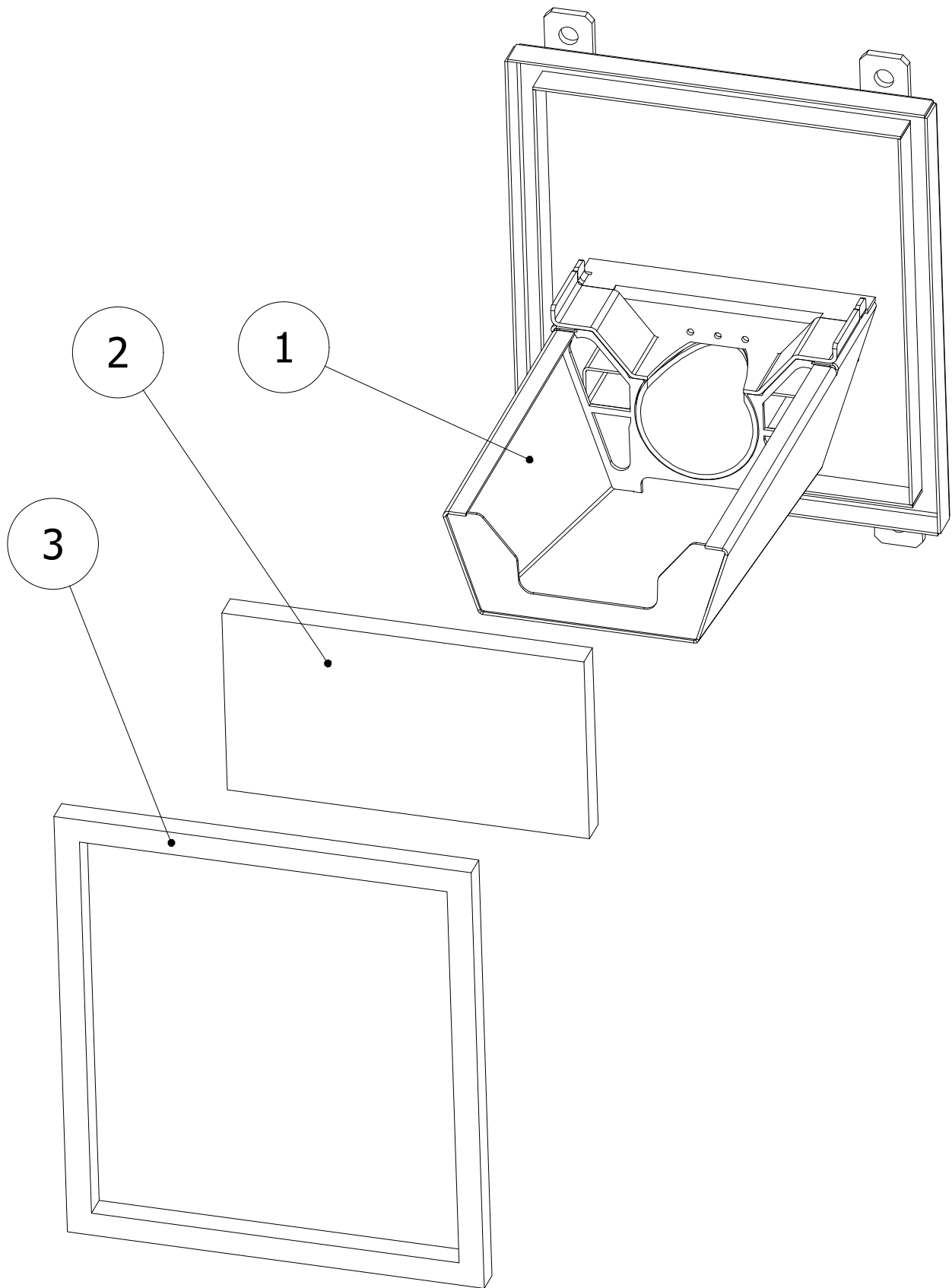
HOŘÁK KP51 SVAŘENEC+TĚSNĚNÍ+SIBREX



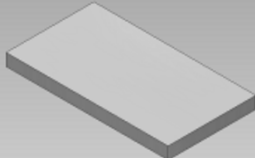
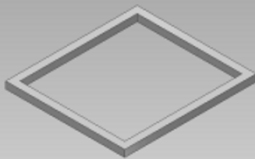



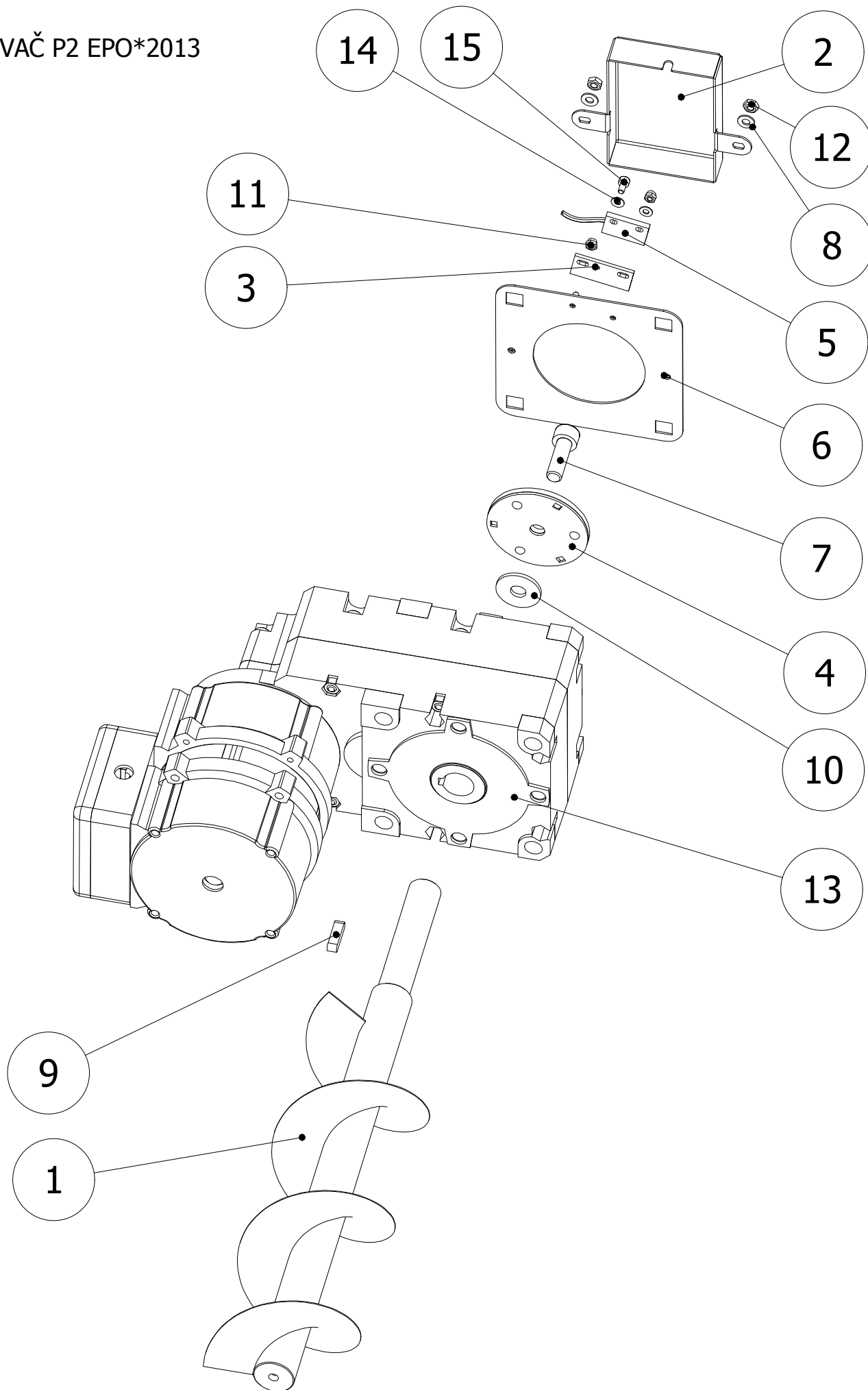

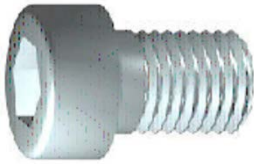

HOŘÁK KP51 SVAŘENEC+TĚSNĚNÍ+SIBREX	POZICE	POPIS	KÓD	ČÍSLO SOUČÁSTI	POZICE KS	POZNÁMKY
	1	HOŘÁK KP51- SVAŘENEC UNI	PHXX5101	523.S00.000.A3	1	
	2	SIBREX 300 20x142x260	MTIZ0003		1	
	3	Šňůra těsnící 18x18	MRUZ0133		1,26m	

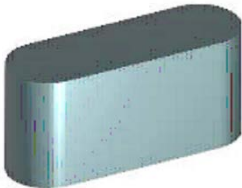
PODAVAČ P2 EPO*2013

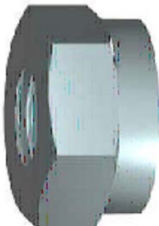

PODAVAČ P2 EPO*2013	POZICE	POPIS	KÓD	ČÍSLO SOUČÁSTI	POČET KS	POZNÁMKY
	1	ŠNEK KP51 ABM	PHXX0053	493.S19.000.A3	1	Délka 353,5mm
	2	KRABÍČKA SNÍMAČE SIGMATEK	MHVH0115	786.000.000.A4	1	
	3	Adaptér pro MK04	PHXX0214	798.110.001.A4	1	
	4	KOLO SNÍMAČE MEDER MK04/EPO	PHXX0213	PHXX0213	1	
	5	Snímač MEDER MK04- 1A66-dl. 1900mm	MERX0777		1	
	6	DRŽÁK SNÍMAČE OTÁČEK	MHVH0119	428.100.000.A4	1	

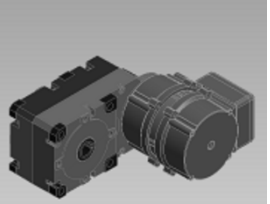
PODAVAČ P2 EPO*2013	POZICE	POPIS	KÓD	ČÍSLO SOUČÁSTI	POČET KS	POZNÁMKY
	7	Šroub s válcovou hlavou - M8 x 25	MSSX0095	DIN 912	1	
	8	Ploché podložky - 4	MSPX0014	ISO 7089	2	
	9	Těsné pero 5e7 x 5 x 20	MSRX0005	DIN 6885	1	
	10	Podložka - 8,4	MSPX0008	DIN 9021	1	
	11	Šestihranná matice pojistná - M3	MSMX0024	DIN 985	2	
	12	Šestihranné matice - M4	MSSX0012	ISO 4032	2	

PODAVAČ P2 EPO*2013	POZICE	POPIS	KÓD	ČÍSLO SOUČÁSTI	POČET KS	POZNÁMKY
	13	Motor EPO MRB 0,06kW/4p	MEMP0035		1	
	14	Ploché podložky - 3	MSPX0031	ISO 7089	2	
	15	Šroub s válcovou hlavou - M3 x 6	MSSX0226	DIN 912	1	

VYMETÁNÍ POPELE

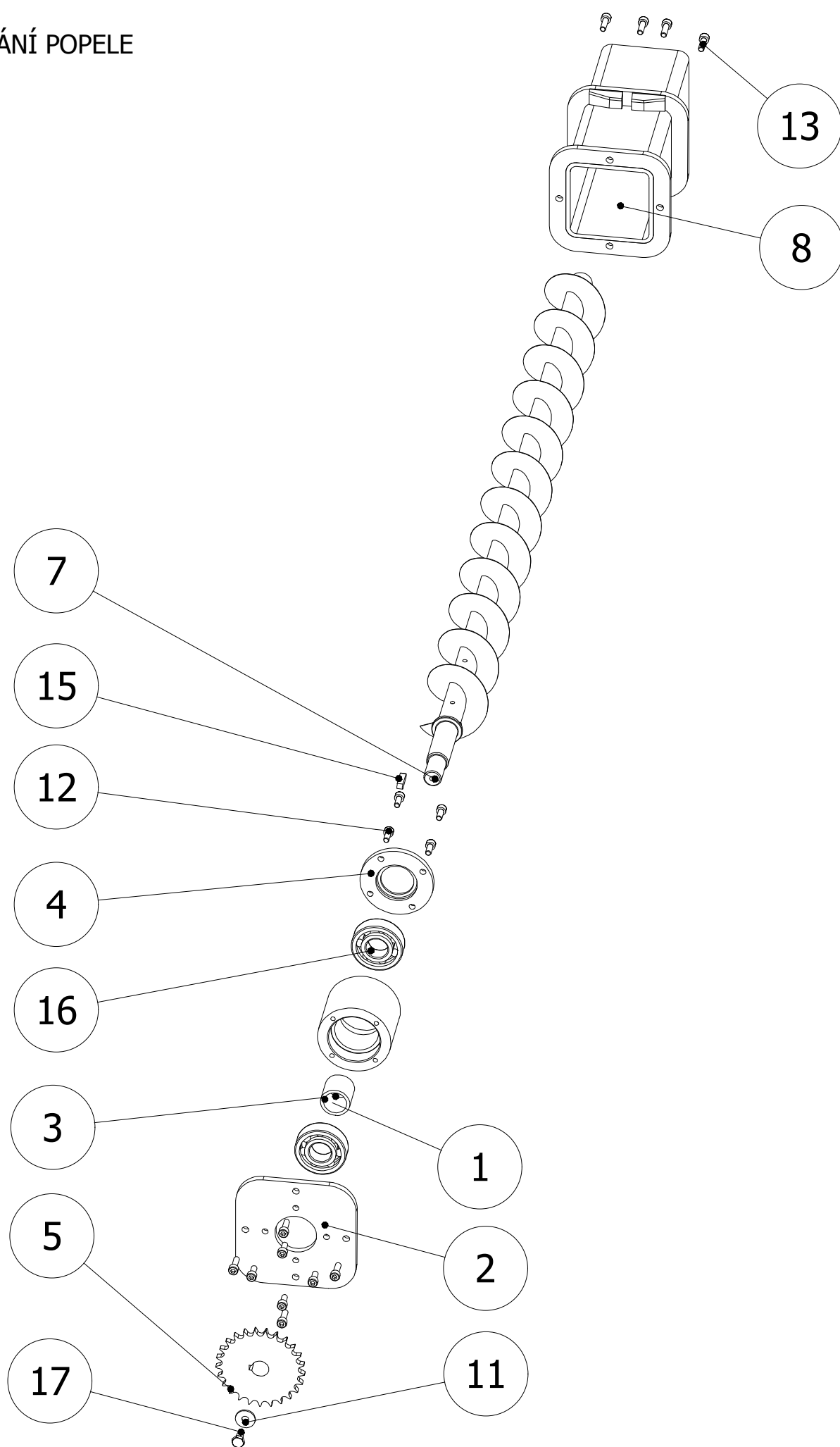

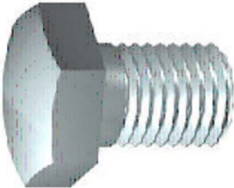

VYMETÁNÍ POPELE KP52S	POZICE	POPIS	KÓD	ČÍSLO SOUČÁSTI	POČET KS	POZNÁMKY
	1	NÁBOJ	PKTX0140	334.001.000.A4	1	
	2	VÍKO 1	PKTX0150	334.002.000.A4	1	
	3	DISTANCE	PKTX0440	334.003.000.A4	1	
	4	VÍKO 2	PKTX0144	334.006.000.A4	1	
	5	KOLO ŘETĚZOVÉ S NÁB.3/8"x7/3 2"	PKTX0143	334.005.000.A4	1	
	7	ŠNEK	PKTX0146	334.S07.000.A3	1	

VYMETÁNÍ POPELE KP52S	POZICE	POPIS	KÓD	ČÍSLO SOUČÁSTI	POČET KS	POZNÁMKY
	8	VEDENÍ ŠNEKU	PKTX0153	334.S08.000.A3	1	
	11	Podložka - 6,4	MSPX0011	DIN 9021	1	
	12	Šroub s válcovou hlavou - M5 x 12	MSSX0137	DIN 912	8	
	13	Šroub s válcovou hlavou - M5 x 16	MSSX0055	DIN 912	8	
	15	Těsné pero - A 5 x 5 x 22	MSRX0006	DIN 6885 - A	1	
	16	Kuličková ložiska jednořadá - 6204	MRUZ004 9	CSN 02 4630	2	

VYMETÁNÍ POPELE KP52S	POZICE	POPIS	KÓD	ČÍSLO SOUČÁSTI	POČET KS	POZNÁMKY
	17	Šestihranný šroub - M6 x 10	MSSX0019	DIN 933	1	Zn

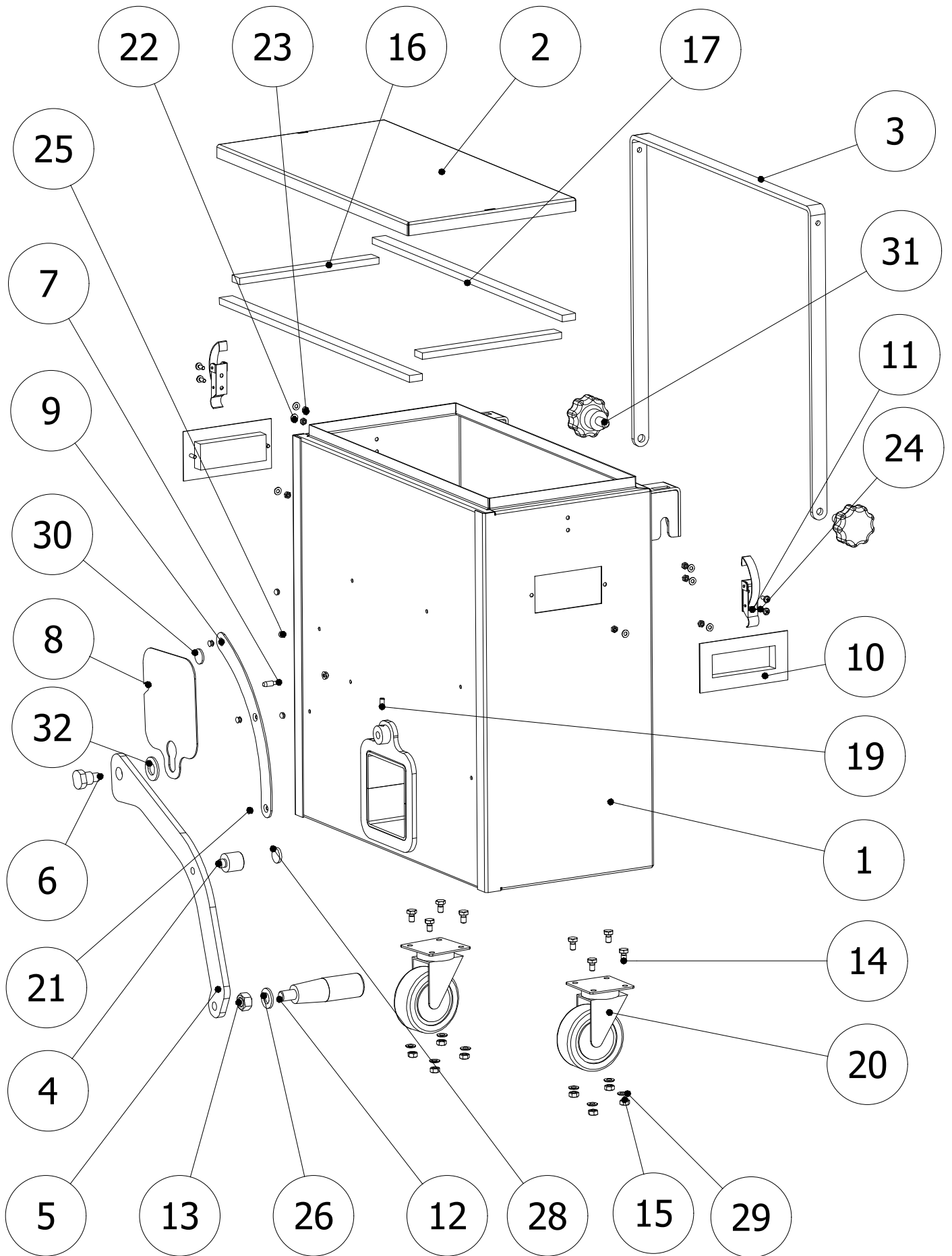
POPELNICE 45L

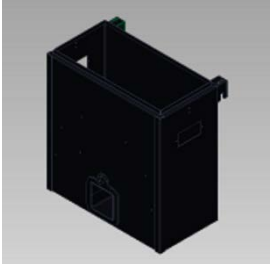
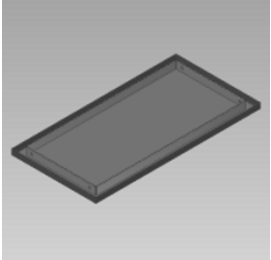
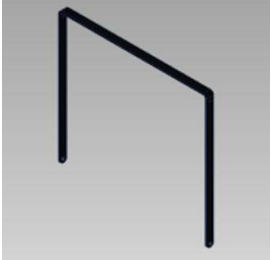
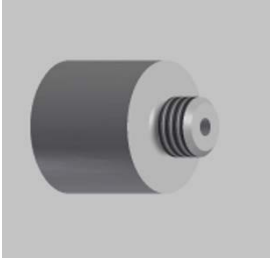

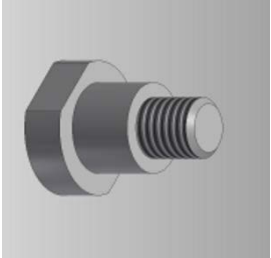



POPELNICE 45L	POZICE	POPIS	KÓD	ČÍSLO SOUČÁSTI	POČET KS	POZNÁMKY
	1	POPELNICE 45L OBAL	PKTD0182	568.S01.000.A3	1	
	2	DEKL POPELNICE 45L	PKTBB0193	568.S03.000.A4	1	
	3	DRŽADLO	PKTD0199	448.011.000.A4	1	
	4	DRŽÁK MAGNETICKÝ	PKTX0198	448.009.000.A4	1	
	5	PÁKA	PKTD0196	448.005.000.A3	1	
	6	ŠROUB	PKTX0197	448.006.000.A4	1	

POPELNICE 45L	POZICE	POPIS	KÓD	ČÍSLO SOUČÁSTI	POČET KS	POZNÁMKY
	7	DISTANCE	PKMX0037	054.009.003.A4	1	
	8	ZÁKLOPKA	MHVT0186	448.012.000.A4	1	
	9	DRÁHA	PKTX0201	448.028.000.A4	1	
	10	ÚCHYTKA ZAPUŠTĚNÁ UWAUNS	MRUZ0200	ÚCHYT	2	
	11	UZÁVĚR UP3	MRUZ0010		2	
	12	DLOUHÁ KUŽ. RUKOJEŤ	MRUZ0062	OBJ.Č.460650	1	

POPELNICE 45L	POZICE	POPIS	KÓD	ČÍSLO SOUČÁSTI	POČET KS	POZNÁMKY
	13	Šestihranné matice - M12	MSMX0007	ISO 4032	1	
	14	Šestihranný šroub - M6 x 10	MSSX0019	DIN 933	8	Zn
	15	Šestihranné matice - M6	MSMX0001	ISO 4032	8	
	16	TĚSNĚNÍ SILIKONOVÉ 8x18-190	MRUZ0090		2	
	17	TĚSNĚNÍ SILIKONOVÉ 8x18-443	MRUZ0122		2	
	19	Šroub stavěcí M5x10	MSRX0015	ISO 7434	1	

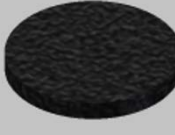
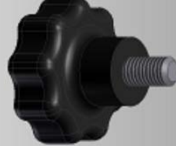
POPELNICE 45L	POZICE	POPIS	KÓD	ČÍSLO SOUČÁSTI	POČET KS	POZNÁMKY
	20	KOLO PEVNÉ EGA 075/FLP PR.75	MRUZ0056	FA.MONTAKO	2	
	21	Nýt se záp.hl. 4x8 Al	MSRX0013		3	
	22	Ploché podložky - 4	MSPX0014	ISO 7089	9	
	23	Šestihránné matice - M4	MSSX0012	ISO 4032	9	
	24	Šrouby s válč. hl. s kří. drážk. - M4 x 10	MSSX0010	ISO 7045	4	
	25	Nýt trhací 4 x 8 Al	MSRX0013	DIN 660 - A	3	

POPELNICE 45L	POZICE	POPIS	KÓD	ČÍSLO SOUČÁSTI	POČET KS	POZNÁMKY
	26	Ploché podložky - 12	MSPX0020	ISO 7089	1	
	28	MAGNET 18x3	MRUZ0088		1	
	29	Ploché podložky - 6	MSPX0026	ISO 7090	8	
	30	MAGNET 18x2	MRUZ0077		1	
	31	ŠROUB KOVOVÝ S PLAST.HLAVOU M10x17	MRUZ0032	OBJ.Č.105a-068-D/MxL	2	
	32	Podložka - A 16	MSPX0022	DIN 125	1	

MECHANISMUS ČISTĚNÍ

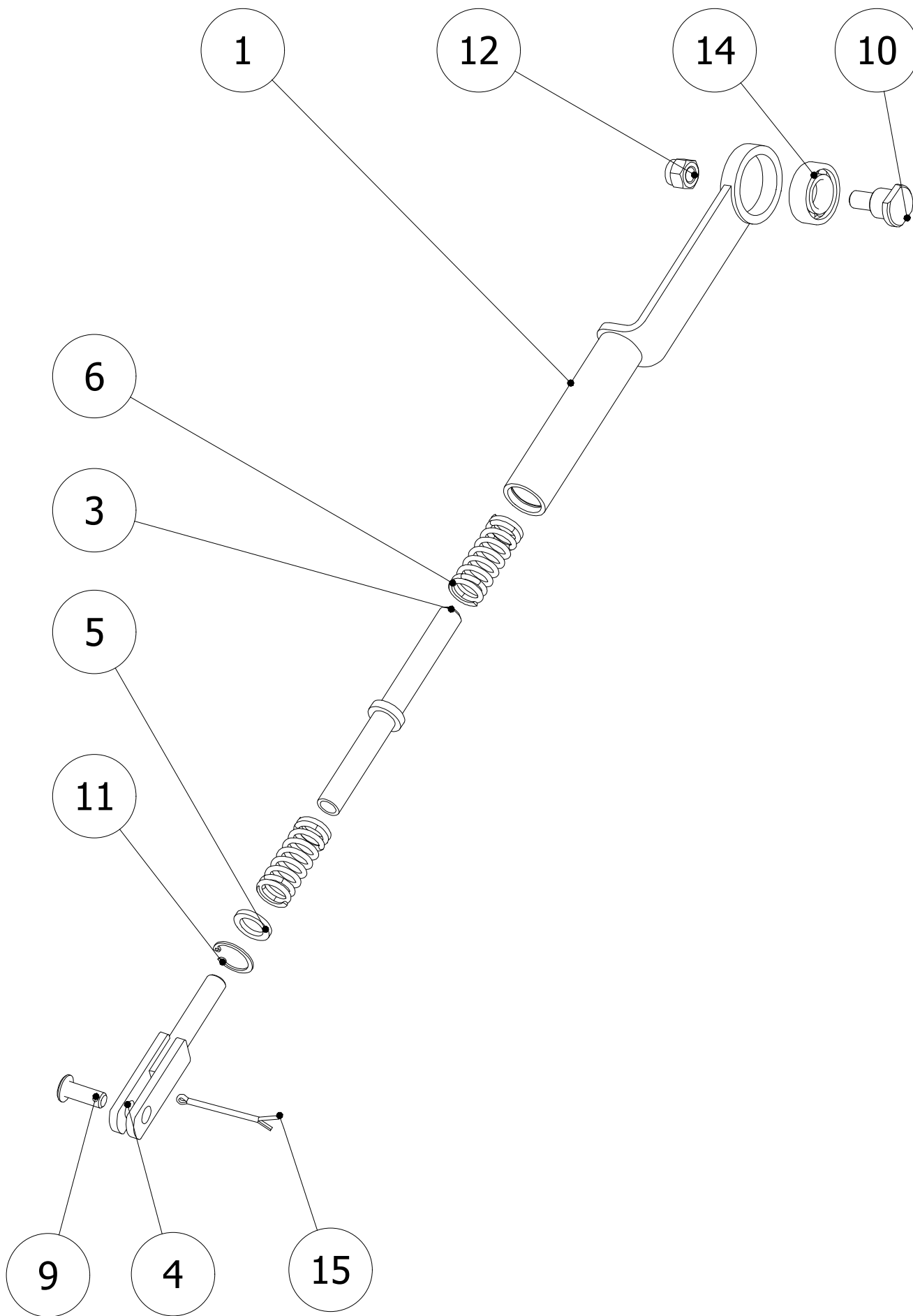

Mechanismus čistění	POZICE	POPIS	KÓD	ČÍSLO SOUČÁSTI	POČET KS	POZNÁMKY
	1	ÓJE ČISTĚNÍ	PKTX0167	424.S01.000.A4	1	
	3	ČEP VEDENÍ	PKTX0170	424.003.000.A4	1	
	4	VIDLICE	PKTX0171	424.S04.000.A4	1	
	5	VÍČKO	MHVT0139	424.005.000.A4	1	
	6	PRUŽINA TLAČNÁ	MRUZ0065		2	
	9	ČEP 1	PKTX0175	424.009.000.A4	1	

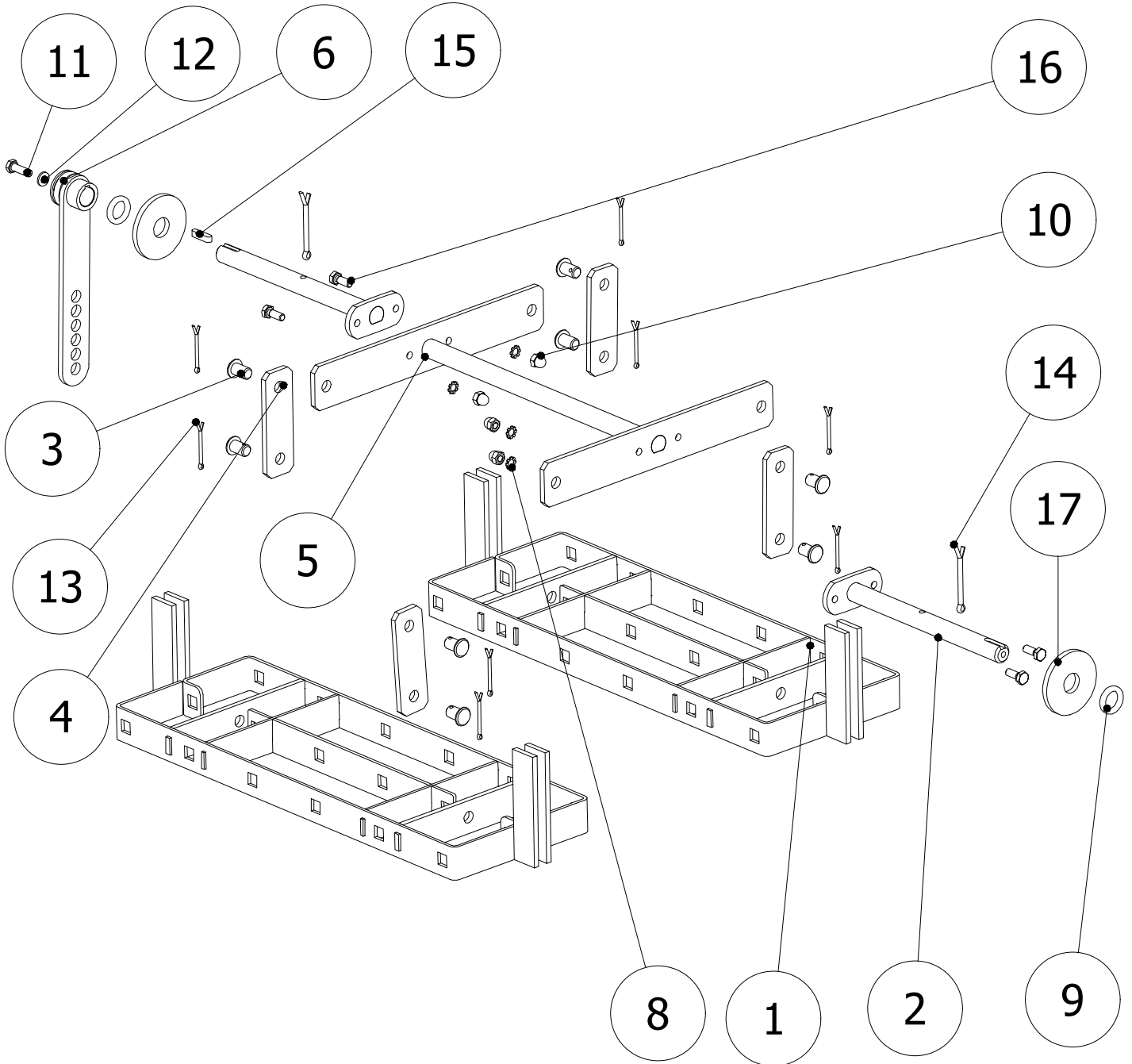

Mechanismus čišění	POZICE	POPIS	KÓD	ČÍSLO SOUČÁSTI	POČET KS	POZNÁMKY
	10	ČEP	PKTX0176	424.010.000.A4	1	
	11	Pojistné kroužky pro díry - 22	MSRX0014	CSN 02 2931	1	
	12	Samojistné šestihřanné matice - M10	MSMX0006	ISO 7041	1	
	14	Kuličková ložiska jednořadá - 6003 2RS	MRUZ0048	CSN 02 4630	1	
	15	Závlačka - 3,2 x 50	MSRX0059	ISO 1234	1	

ČISTĚNÍ VÝMĚNÍKU

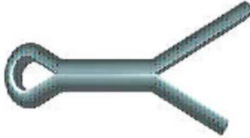
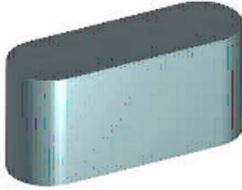
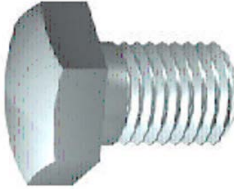

ČISTĚNÍ VÝMĚNÍKU	POZICE	POPIS	KÓD	ČÍSLO SOUČÁSTI	POČET KS	POZNÁMKY
	1	VAHADLO	PKTX0391	797.S01.000.A3	2	
	2	NÁSTAVEC	PKTX0389	797.S06.S00.A4	2	
	3	ČEP	PKTX0053	005.S16.007.A4	8	
	4	ZÁVĚS	PKTX0051	005.S16.004.A4	4	
	5	HŘÍDEL SPOJOVACÍ	PKTX0340	761.S06.A00.A3	1	
	6	RAMENO	PKTX0163	445.S08.000.A4	1	

ČISTĚNÍ VÝMĚNÍKU	POZICE	POPIS	KÓD	ČÍSLO SOUČÁSTI	POČET KS	POZNÁMKY
	8	Vějířová pojistná podložka- A 6,4	MSPX0012	DIN 6797	4	
	9	Šňůra těs. čišťení 4x4	PKTX0432		2	
	10	Šestihranná matice uzavřená - M6	MSMX0027	DIN 1587	4	
	11	Šestihranný šroub - M6 x 20	MSSX0006	ISO 4017	1	Zn
	12	Ploché podložky - 6 - 140 HV	MSPX0026	ISO 7089	1	
	13	Závlačka - 2,5 x 36	MSRX0048	ISO 1234	8	

ČISTĚNÍ VÝMĚNÍKU	POZICE	POPIS	KÓD	ČÍSLO SOUČÁSTI	POČET KS	POZNÁMKY
	14	Závlačka - 4 x 50	MSRX0021	ISO 1234	2	
	15	Těsné pero - A 5 x 5 x 22	MSRX0006	DIN 6885	1	
	16	Šestihranný šroub - M6 x 16	MSSX0015	DIN 933	4	
	17	Ploché podložky - ST 16 - 100 HV	MSPX0030	ISO 7094	2	

POHON VYMETÁNÍ POPELE

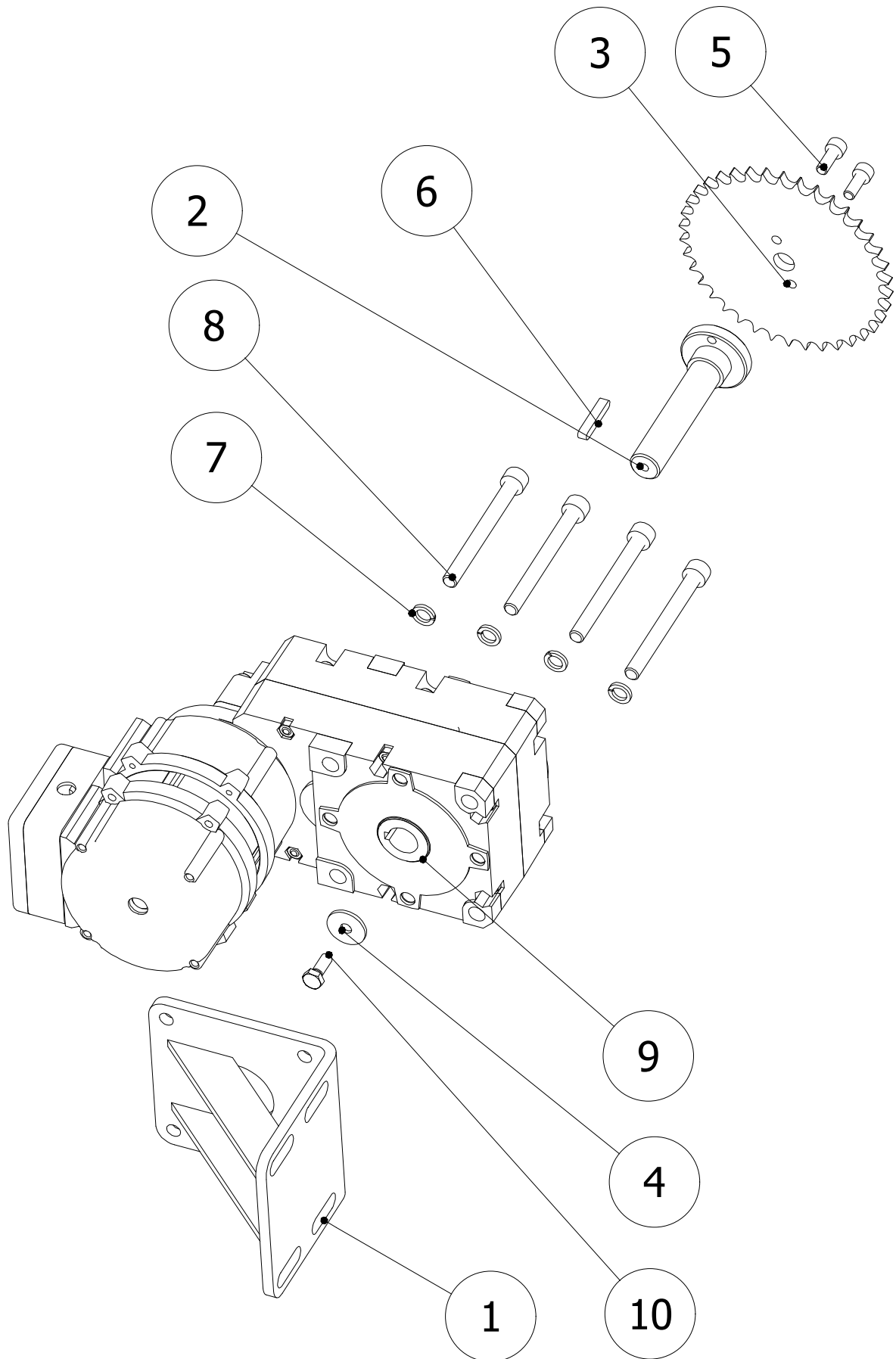

Pohon vymetání popelé KP52S	POZICE	POPIS	KÓD	ČÍSLO SOUČÁSTI	POČET KS	POZNÁMKY
	1	DRŽÁK MOTORU ABM	PKTX0216	446.S01.000.A3	1	
	2	UNAŠEČ	PKTX0218	446.002.000.A3	1	
	3	KOLO ŘETĚZOVÉ ÚPRAVA	PKTX0225	446.003.000.A4	1	
	4	Podložka 6	MSPX0011	DIN 440R	1	
	5	Šroub s válcovou hlavou - M6 x 16	MSSX0098	ISO 4762	2	
	6	Těsné pero - A 5 x 5 x 30	MSRX0007	DIN 6885	1	

Pohon vymetání popelé KP52S	POZICE	POPIS	KÓD	ČÍSLO SOUČÁSTI	POČET KS	POZNÁMKY
	7	Pružná podložka - 8	MSPX0006	DIN 7980	4	
	8	Šroub s válcovou hlavou - M8 x 80	MSSX0045	DIN 912	4	
	9	Motor EPO MRB 0,06kW/4p	MEMP0035		1	
	10	Šestihranný šroub - M6 x 16	MSSX0015	DIN 933	1	
	11	ŘETĚZ 06 B-1, 103 ČLÁNKŮ (3.8x7.32)	MRUZ0141		1	
	12	ČLÁNEK SPOJOVACÍ JEDNOŘ.	MRUZ0041		1	
	13	Kabel SIHF 3G 1	MEKV0003		1,2m	

ELEKTRO

KÓD	POPIS	MNOŽSTVÍ
MEKV0003	Kabel SIHF 3G 1	3,44 m
MEKV0006	Kabel H07 V-K 2.5 zž.	0,176 m
MEKV0007	Kabel SIHF 3x1.5	1,0 m
MEKV0037	Kabel H07V-K 1,5 zž	3,0 m
MEKV0047	Šňůra FLEX H05VV-F 3x1,5 5m	1,0 ks
MEKV0054	Kabel CSSS 2Dx1/VO5SS-F/ silikon	1,0 m
MEKV0065	Kabel LiYY 4x0,14	5,0 m
MEKV0070	Kabel H05VV-F 4G1,5B	4,5 m
MEKV0071	Kabel H07V-K 1,5 sv.modr	2,5 m
MEKV0072	Kabel H07V-K 1,5 černý	3,0 m
MERX0003	Objímka plochá BF-F 608P	8,0 ks
MERX0004	Dutinka lis. DI 1.0-10 10	37,0 ks
MERX0016	Svorka WAGO 222-413	4,0 ks
MERX0020	Canon 9 V (RKP 12157)	1,0 ks
MERX0027	Trubička smršť. 3,2/1,6 SB/PBF-1/8	0,05 m
MERX0030	Objímka plochá RF-F 608P	3,0 ks
MERX0043	Canon sada matic CTB	1,0 ks
MERX0051	Vývodka PG 9 s matkou	16,0 ks
MERX0067	Přichytka PKB-BS 27x27mm přírodní samolepící	3,0 ks
MERX0073	Svorka WAGO 222-415	1,0 ks
MERX0078	Štítek uzemění malý /baleno po 40 ks/	4,0 ks
MERX0126	Oko lisovací RF-M4	6,0 ks
MERX0151	Spirála svazkovácí SPC10	1,0 m
MERX0158	Pásek vázací 200/3,6	8,0 ks
MERX0205	Vývodka PG 7	9,0 ks
MERX0221	Kolík ploch.přístroj. SEZC7202-00/4/100	4,0 ks
MERX0237	Konektor RJ 45-8/8 C5 dr vidlice	1,0 ks
MERX0282	Konektor RJ 45-8 Cat.5e UTP	1,0 ks
MERX0529	Kolík dvojitý 7242-00/5/4	1,0 ks
MERX0581	Filtr odrušovací MIFLEX FP-250/16	1,0 ks
MERX0621	Matka Pg 7 sv. šedá	9,0 ks
MERX0631	Konektor 2,5 / 3 green SIGMATEK	16,0 ks
MERX0632	Konektor 1,5 / 2 green SIGMATEK	15,0 ks
MERX0633	Konektor 2,5 / 2 green SIGMATEK	1,0 ks
MERX0634	Konektor 2,5 / 4 green SIGMATEK	4,0 ks
MERX0635	Konektor 1,5 / 4 green SIGMATEK	1,0 ks
MERX0636	Konektor 1,5 / 3 green SIGMATEK	1,0 ks
MERX0641	Kryt P - Canon 9	1,0 ks
MERX0648	Spirála svazkovácí SPC15	0,5 m
MERX0661	Buž. smršť. SB 3,2/1,6 Mo modrá	0,06 m
MERX0662	Zástrčka ST18 -3 pol.č. Wieland	1,0 ks
METR0071	Deska základní HZS 521-G	1,0 ks
METR0072	Modul expandér HZS 532-1	1,0 ks
METR0083	Snímač teploty příložený KS 154A KTY 81-110, 3,5m	2,0 ks
METR0085	Snímač teploty TG8-55 KTY 81-110, 1,5m voda	1,0 ks
METR0087	Snímač teploty pro ven. KS 114B, KTY 81-110	1,0 ks
METR0108	Snímač teploty TR 050J-x TCK,silicon zelený 1,4m	1,0 ks

KÓD	POPIS	MNOŽSTVÍ
MREZ0012	Etiketa stříbrná 210x297	1,0 ks
MRUZ0211	FlaschDisk USB 2,0 Sandisk Cruzer Fit 8GB	1,0 ks
MRUZ0219	Průchodka 24,9 x 1,6 Moss 11214	1,0 ks
MRUZ0220	Podložka tlum. 10x10x2,5 čtvercová 35604-0	5,0 ks
MRUZ0272	Zátka antivibrační 1/2 BSP - velikost 8	1,0 ks
MRUZ0274	Zátka souběžná 46.1MM č.465668	3,0 ks
MRUZ0275	Fólie laminovací A4	1,0 ks
PKEX0038	Kabeláž KP 52S,62S-2,5 m	1,0 ks

PONAST spol. s r.o
Na Potůčkách 163
757 01 Valašské Meziříčí

ČESKÁ REPUBLIKA

www.ponast.cz

tel.: 571 688 111*, 800 700 068

e-mail: servis@ponast.cz